

# STEEL+ TECHNOLOGY

THE TECHNICAL MAGAZINE FOR IRON AND STEEL PROFESSIONALS AROUND THE WORLD



[WWW.HOMEOFSTEEL.DE](http://WWW.HOMEOFSTEEL.DE)

## STEEL COMPANIES

Implementation of the new continuous casting plant at Saarstahl is on track

## STEEL TECHNOLOGY

Ultra-thin hot rolled strip with only 0.6 mm thickness produced on Arvedi ESP line

## STEEL DISTRIBUTION

Klößner & Co enters into a strategic partnership with Axel Springer hy

## ADDITIVE MANUFACTURING

3D spray head for forging presses wins German Design Award

# LEADING PARTNER IN THE WORLD OF METALS

SMS group is your leading partner in the world of metals. As a family-owned business headquartered in Germany, quality and innovation are in our DNA. Fast and flexible, we develop individual and modular solutions – whether it's the design of a new plant, **Modernization, Digitalization, or Life Cycle Services**. In close **Collaboration** with you, we help you ensure your success. Let's add value along the entire value chain, together.

**Leading partner in the world of metals**



## Dear readers,

DVS Media presents to you the first issue of the new journal STEEL + TECHNOLOGY – featuring news and technical information from the steel producing, steel distributing and steel application sectors. The printed journal lying in front of you is supplemented by various digital media channels, such as an app, the online platform HOME OF STEEL and social media activities. With the launch of STEEL + TECHNOLOGY, the publisher is expanding its range of B2B media by the subject field of “steel”.

Steel is an ageless, innovative material with a virtually never-ending development potential. New steels are indispensable in coping with the challenges posed by mobility and construction issues, novel engineering tasks and, last but not least, the protection of our environment. The steel business – from iron and steelmaking via steel distribution down to steel processing – has always been characterized by a great deal of innovation and creativeness. Ingenious heads research, design and engineer with steel. Virtually every day brings about a wealth of new, exciting steel-related information that you should not miss. STEEL + TECHNOLOGY will from now on observe the developments in the international steel sector and relay this information to you via our print and digital media channels.

As a renowned specialist publishing house, DVS Media has decades of experience in the print media which has been supplemented by numerous digital ranges in the recent years. From now on, stakeholders in the steel sector will be able to benefit from this know-how in print, online and mobile media. By bringing to bear in-depth expertise, STEEL + TECHNOLOGY aspires to become a mainstay of steel-related journalism and the leading medium for the international steel community. By the way, there is a German-language counterpart, STAHL + TECHNIK with a special focus on the markets in Austria, Germany, Switzerland and the Benelux, but with the same aspiration in terms of steel know-how and value of information.

Immerse yourselves in our diverse landscape of business news and technical information from the international world of steel. Don't hesitate to contact us for ideas and suggestions on topics of interest for coverage in one of our media.



**Arnt Hannewald**, Dipl.-Ing.  
Editor

## Events

- 28 Trade fair quartet GIFA, NEWCAST, METEC and THERMPROCESS 2019

## Companies

- 30 Agreement for ground breaking energy project "Salzgitter Clean Hydrogen"
- 32 Green hydrogen for large-scale commercial projects
- 33 GSB Group to become a member of Dalmia Bharat Group
- 34 Joint venture between DP World and SMS group to build new container storage system
- 36 Additively manufactured 3D spray head wins German Design Award

## Steel technology

### Ironmaking/Steelmaking

- 38 Evraz NTMK to reconstruct blast furnace No. 6
- 39 Blast furnace at Tata Steel Kalinganagar back in operation after hearth chill
- 40 Outokumpu to invest at the Tornio, Finland, production site
- 41 Acciaieria Arvedi commissions new electric arc furnace

### Casting/Rolling/Forging

- 42 New continuous casting plant is on track at Saarstahl
- 44 New mould design for continuous bloom and billet casters



- 45 Advanced pulsating spray cooling system for strand cooling

- 46 Continuous optical position measurement

- 47 Nucor to modernize the Gallatin hot strip plant

- 50 Ultra-thin hot rolled strip with only 0.6 mm thickness

- 51 Weber Metals unveils new giant die forging press

### Strip processing

- 54 Heinrich Georg demonstrates innovative power at a recent in-house exhibition

- 57 Solutions for the heat treatment of electrical steel strip

- 60 Innovative cold strip complex at Baosteel

- 62 Marcegaglia to strengthen cold strip production at the Ravenna site

- 63 High-precision measurement of internal tube contours

- 64 Smart Alarm – an intelligent alarm and maintenance system

## Steel processing

- 68 ArcelorMittal starts new initiative on solutions in sheet piles

- 70 Steel-built railway bridge wins Dutch Steel Award

- 71 Complex steel components from the 3D printer

- 72 Kobe Steel to expand steel powder production



**73** Process-reliable welding of steel and aluminium parts

## Steel distribution

**76** Digital transformation: Klöckner & Co enters into partnership with Axel Springer

**77** Perspectives for the global market for electrical steel

**79** Kicherer implements an innovative warehouse for bars and bundles

**81** Powered pallet truck nominated for the IFOY Award

## Panorama

**82** Digital classroom with virtual and augmented reality

**84** Virtual reality in the field to train maintenance staff

**85** Steel construction – a vision to master UK housing crisis

**87** A Lego model blast furnace

**88** The iron and steel industry in the Ukraine during World War I

## Columns

**3** Editorial

**8** People

**9** News round-up

**93** Steel diary

**94** Advertisers' index

**94** Outlook, imprint



**Cover picture:** © Friedrich Kocks GmbH & Co KG

Kocks RSB® 370++ with 4 stand positions will be operating at Jiangsu Yonggang Group Co., Ltd. in China. With Yonggang's decision to invest in the 5th generation of the Kocks reducing & sizing technology, the sound barrier of worldwide 100 references was broken.

**|** Friedrich Kocks GmbH & Co KG,  
Hilden, Germany  
Internet: [www.kocks.de](http://www.kocks.de)  
E-mail: [fk@kocks.de](mailto:fk@kocks.de)

# DANIELI

Through planning, complete systems integration and construction with our own heavy lifting equipment, provide our teams with full operational flexibility. Danieli Engineering and Danieli Construction International: your trusted partner with 37 years of experience in on-time project delivery and cost management.

## 138

TURNKEY PLANTS  
SUPPLIED  
WORLDWIDE



## 38

ENERGIRON  
DIRECT REDUCTION  
PLANTS



## 570

SCRAP SHEARS  
AND SHREDDERS



## 235

ELECTRIC  
ARC FURNACES

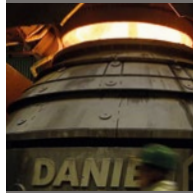

## 147

BLAST FURNACE  
AND CONVERTER  
PROJECTS



## 382

SECONDARY  
METALLURGY  
STATIONS



## 2313

CASTING STRANDS  
FOR SLABS, BLOOMS,  
AND BILLETS

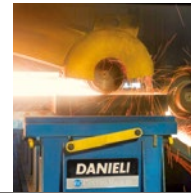

## 1105

SLAB, BLOOM,  
AND BILLET  
GRINDING MACHINES

## 680

PROCESS CONTROL  
SYSTEMS

Danieli Automation automates plants through integrated systems for equipment, process and power control, handling jobs from order placement through product delivery. Event-prediction and problem-solving operator assistance are ensured by the innovative 3Q system.

Danieli Environment offers a full range of proprietary technologies for air pollution control, water treatment, solid waste recovery, noise reduction and energy savings.

## 362

ENVIRONMENTAL  
PLANTS

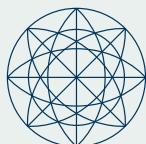

Via Nazionale, 41  
33042 Buttrio (UD) Italy  
Tel (39) 0432.1958111  
Fax (39) 0432.1958289  
info@danieli.com



DANIELI TEAM  
A CENTURY  
OF PARTNERSHIP  
EXPERIENCE



# DANIELI THE RELIABLE INNOVATIVE PARTNER TO BE A STEP AHEAD

Danieli Centro Combustion and Danieli Olivotto Ferrè provide the most efficient and low consumption heating and heat treatment systems for all steel and NF metals production processes.

## 994

HEATING AND  
HEAT TREATMENT  
SYSTEMS

Our original technology, process know-how, in-house design and manufacturing along with proprietary automation systems, environmental solutions and customer service for a competitive and sustainable steel and nonferrous metals industry. Strength and reliability presented by numbers.



## 333

HOT STRIP, PLATE  
AND COLD MILLS



## 505

HEAVY SECTION,  
RAIL, BAR AND  
WIREROD MILLS



## 74

SEAMLESS TUBE  
AND WELDED  
PIPE PLANTS



## 390

EXTRUSION AND  
FORGING PRESSES



## 142

ALUMINIUM HOT  
AND COLD MILLS



## 1799

STRIP  
PROCESSING AND  
FINISHING LINES



## 503

DRAWING  
AND PEELING  
MACHINES

## Current chief financial officer to leave Klöckner & Co SE

**Marcus A. Ketter, the current CFO of Klöckner & Co SE, has decided to leave the company.**

He leaves Klöckner by amicable and mutual consent as of the end of the annual

general meeting in May 2019 to pursue a new professional challenge. Marcus A. Ketter became a member of the management board in 2013 and has been responsible for the finance department since that date. Gisbert Rühl will assume Marcus

A. Ketter's responsibilities in addition to his role as chairman of the management board.

**| Klöckner & Co**

## Changes in the management of SMS group

**SMS group GmbH has expanded its management team, implementing a clear functional organization of the management board with focus on innovative products, efficient order execution and digital processes.**

As of 1 March 2019, Michael Rzepczyk took on the role of chief operating officer of SMS group. Michael Rzepczyk currently serves

as executive vice president of the business unit Metallurgy and is mainly responsible for the execution of major projects.

Prof. Dr. Hans Ferkel, who currently serves as head of technology and innovation at thyssenkrupp Steel Europe AG, will begin his work as chief technology officer of SMS group at the earliest possible date. Next to Prof. Dr. Hans Ferkel and Michael Rzepczyk the five-member management team con-

sists of Torsten Heising (Finance) and Prof. Dr. Katja Windt (Digitalization), headed by long-standing chairman Burkhard Dahmen.

Dr. Guido Kleinschmidt left the management board at his own request on 28 February 2019. He will take up a new role outside SMS group.

**| SMS group**



**Martin Stillger is the new CEO of thyssenkrupp Schulte** (Picture: thyssenkrupp Steel)

## New CEO at thyssenkrupp Schulte

**Effective 1 February 2019, Martin Stillger took over as chairman of the thyssenkrupp Schulte trading organization. His predecessor Ilse Henne joined the Materials Services executive board at the beginning of the year as chief operating officer.**

The 55-year-old, who studied mechanical engineering, brings with him over ten years of management experience from thyssenkrupp Materials Services. Among other things, he has headed the materials

distributor's Eastern European subsidiaries since 2012. He has also been responsible for the business units in the Western Europe region and of Technical Services since 2018. He will continue to hold these positions. Before joining thyssenkrupp, Stillger worked for Barmag AG for 17 years, five of which as sales director and chief executive officer.

**| thyssenkrupp Schulte**

## Martina Merz to chair supervisory board of thyssenkrupp AG

**The supervisory board of thyssenkrupp AG has elected Martina Merz as new chairwoman of the supervisory board.**

Martina Merz takes over the chair from Prof. Dr. Bernhard Pellens, who assumed the position after the resignation of Prof. Dr. Ulrich Lehner and will now once again focus on his role as chairman of the audit committee.

"Now it's about successfully implementing thyssenkrupp's new strategy. At the same time, businesses must remain competitive with their outstanding products and services – in the interest of the employees, customers and shareholders," said Martina Merz after her election.

Martina Merz has decades of management experience in industry, including as a member of the board of the Chassis System

Brakes division of automotive component supplier Bosch. Since 2015 the qualified mechanical engineer has been a member of various supervisory boards as an independent management consultant, including at Lufthansa and the Swedish truck manufacturer Volvo.

**| thyssenkrupp**



## Union Partners names Mark Bula as executive vice president of corporate development

**Union Partners, based in Chicago, USA, has appointed Mark Bula as their new executive vice president of corporate development.**

In his new role, Mark Bula will be responsible for managing and facilitating the growth strategy for Union Partners and their family

of companies. Bula notably spent the last six years of his career at Big River Steel. He was a member of the initial development team at Big River Steel, where he was instrumental in the creation and execution of their go-to-market strategy as well as the direct management of all functional leaders.

Union Partners LLC is a hands-on, full-service metals and logistics company. Their steel service centres specialize in metal distribution and processing, and related logistics services.

■ *Union Partners*

## KSK GmbH adds third member to its management team

**Since the beginning of this year, Andreas Höwedes has been a further member of the managing board of KSK Kuhlmann-System-Kühltechnik GmbH. With this decision, the family-owned business from Haltern, Germany, has prepared for a smooth transition to the next generation.**

The 32-year old will manage the business of heat technology specialists KSK GmbH, along with Carsten Oberhag and Olaf Huscher. Andreas Höwedes, a graduate in business engineering, started his professional career as a business consultant. After three years as a consultant he joined KSK as project manager. "My decision to move on the KSK was driven by the challenge of working for a medium-sized hidden champion of the industry and by the prospect of being near my home town," says Andreas Höwedes. The longstanding managing directors Oberhag and Huscher look forward to working with Höwedes. "Allowing a young person take up the role of a managing director will bring us new ideas and new momentum, and it gives us the time we need to prepare for a smooth



From left to right: Carsten Oberhag, Andreas Höwedes and Olaf Huscher, the three managing directors of KSK Kuhlmann-System-Kühltechnik GmbH (Picture: KSK GmbH)

transition of the company management to the next generation," says Carsten Oberhag. The about 80 employees of the three KSK group companies bring to bear their interdisciplinary knowhow at two locations in Germany. The headquarters of the family-owned group of companies

is located in the German town of Haltern am See.

■ *KSK GmbH*

## Africa: Algeria

### Tosyali Algeria completes direct reduction plant project

**Tosyali Holding has completed construction of its direct reduction ironmaking plant, which can simultaneously produce hot and cold direct reduced iron.**

The 2.5 million t/year plant was supplied by Midrex Technologies and its consor-

tium partner Paul Wurth. The MIDREX® DRI combination plant will feed the EAF melt shop of a new Tosyali Algeria iron and steel facility. Commissioning of the plant began in July 2018, and production of cold DRI (CDRI) started in late November 2018. Hot DRI (HDRI) production is

expected to begin in the first quarter of 2019, which also is the scheduled official plant start-up.

■ *Midrex, Paul Wurth*

## The Americas: Argentina

### Ternium Argentina issues FAC for gas cleaning plants upgrade

**Ternium Argentina has awarded SMS group the final acceptance certificate for the upgraded BOF gas cleaning plants at its San Nicolas works.**

As part of a planned increase in the production capacity of the three 190 t converters, the gas cleaning plants, installed in the 1970s, have been upgraded to the state-of-the-art, now providing far more efficient cleaning results. Offgas emissions have been reduced to below 25 mg/m<sup>3</sup> (stp); the legal limit is 50 mg/m<sup>3</sup> (stp). SMS group supplied key components for the revamp of the three scrubbers, as well

as two main induced-draft fans for the gas cleaning plant. The venturi throat, developed by SMS group, features a new type of nozzle geometry and arrangement, which ensures extraction of a larger quantity of dust particles. SMS group's scope of supply also included the measuring technology for the venturi scrubber and the whole gas cleaning plant, including the cooling stack, as well as the supervision of the erection work and the commissioning process.

■ *SMS group*



The venturi throat makes for highly efficient dust extraction (Picture: SMS group)

## The Americas: Brazil

### Usiminas to build new converter

**Usinas Siderúrgicas de Minas Gerais S.A. (Usiminas) has contracted Danieli Corus for the replacement of a converter at their Ipatinga integrated steel-works.**

The new 180 t converter, which Danieli Corus is going to supply to Usiminas, will be equipped with the patented

suspension system based on a vertical lamella arrangement in combination with horizontal elements, an air cooling system for the barrel part of the vessel and water-based cooling for the vessel's top cone. A temperature monitoring system and automation packages will also be installed as part of this revamp project.

The converter vessel will be built by sub-contractor Usimec, an Usiminas subsidiary, while design, supply and supervision are part of the Danieli Corus scope. Production of the first heat with the new converter is scheduled for early 2020.

■ *Danieli Corus*

## The Americas: Brazil

### ArcelorMittal evacuates community around Serra Azul tailing dam

**ArcelorMittal has decided to put in practice the evacuation plan related to its dormant Serra Azul tailing dam following the recent incidents in the Brazilian mining sector.**

The action follows an updated site-based assessment commissioned by ArcelorMittal Mining of the tailing dam by the Independ-

ent Tailings Review Panel. The assessment included stress tests on the Serra Azul pond applying early observations available from the Feijao dam. Based on the range of factors of safety evaluation, a decision was taken to evacuate all residents as a purely precautionary measure, while further testing is undertaken and any mitigation measures can be implemented. They will remain

in temporary accommodation while further tests are ongoing and until the security of the tailing pond can be 100% guaranteed. The Serra Azul mine is located in Itatiaiuçu, Minas Gerais State. It produces 1.2 million t of concentrate and lump ore.

■ *ArcelorMittal*

## The Americas: Chile

### CAP Acero continues meltshop modernization

**Following the successful start-up of converter No. 2 in May 2018, Compania Siderurgica Huachipato now awarded Primetals Technologies the order to replace LD (BOF) converter No. 1 in its Talcahuano works.**

The revamp of converter No.1 is planned to follow the same setup regarding technologies, scope split and execution as the project for converter

No. 2. After the revamp, converter No. 1 will have a tapping weight of 100 t and a larger reaction volume, which will improve the metallurgical process. Converter vessel and trunnion ring will be suspended by the maintenance-free Vaicon

**Converter 2 at CAP Acero in Talcahuano, Chile, has already been successfully revamped** (Picture: CAP Acero)



Link 2.0 system. The modernized converter is scheduled to come into operation in March 2020.

In addition, CAP ACERO also ordered the installation of Primetals Technologies' Vaicon stopper slag retention system on converter No. 2. The scope of supply of the slag retain-

ing system comprises the infrared camera driven slag detection system SlagMon for early and reliable detection of slag at the end of tapping, the pneumatic actuated slag stopper unit for pneumatic sealing of the tap hole as well as the media supply system. The

Vaicon Stopper is connected to the converter with a quick exchange device. The system is scheduled to be installed in spring 2019.

| *Primetals Technologies*

## The Americas: Colombia

### Ternium del Atlántico orders compact coiler for bar mill

**SMS group is to supply a VCC® (vertical compact coiler) to Ternium del Atlántico SAS. The coiler will be installed in the Palmar de Varelat bar mill in Barranquilla.**

SMS group's vertical compact coiler (VCC) technology produces compact and torsion-free coils

of bar and rebar. Coils made with this system have preselected dimensions that remain consistent for all products processed on the same line. The compact coil size is ideal for storage, transport and handling. One of the most important features of the system is its method of coiling the bar directly in the vertical position.

Once in operation at Ternium, the plant will produce rebars from 8 to 16 mm in diameter at speeds of up to 35 m/s. The output will be 120 t/h with coils weighing up to 3 t.

| *SMS group*

## The Americas: USA

### Steel Dynamics to increase hot-dip galvanizing capacity

**The Columbus Flat Roll Division of SDI is going to add a new continuous hot-dip galvanizing line to its plant in Columbus, Mississippi, to diversify its product portfolio. The order for the new line has been awarded to Fives.**

Fives' project scope will include design, supply and commissioning of the complete No. 3 continuous hot-dip galvanizing line, which will be designed to produce 400,000 t/year. The supply will comprise the entry and exit coil handling sections, a degreasing section, a horizontal annealing furnace, hot-

dip galvanizing and cooling equipment, a skin-pass mill and strip leveller. Also inspection systems, metallurgical assistance for different steel grades and types of coating, as well as construction and commissioning assistance will be provided by Fives. The line will be used to produce unexposed automotive steel grades, as well as other commercial and specialized steel grades. Commissioning is scheduled to take place in mid-2020.

| *Fives*



Continuous hot-dip galvanizing line in operation (Picture: Fives)

### Steel Dynamics to acquire majority share of United Steel Supply

**Steel Dynamics has entered into a definitive agreement to acquire 75% of the equity interest of United Steel Supply.**

The agreement provides Steel Dynamics the option to also purchase the remaining 25% equity interest of United Steel Supply in the future. United Steel Supply distrib-

utes painted and coated flat roll steel coils to the niche regional roll-former market, serving the roofing and siding industry. It is headquartered in Austin, Texas, with four distribution centres strategically located in Mississippi, Indiana, Arkansas, and Oregon.

"United Steel Supply provides an exciting opportunity to expand our painted

Galvalume® value chain, by affording us with a better opportunity to provide our high-quality flat roll steel directly to this important market segment," says Mark D. Millett, president and chief executive officer.

| *Steel Dynamics Inc.*

### Vinton Steel to upgrade bar mill

**Vinton Steel LLC of Vinton, Texas, has signed a contract with Primetals Technologies for an upgrade of its bar mill.**

The upgrade will enable Vinton to reduce delays, increase productivity, improve bundle quality, and enable the mill to handle bar

up to 24 m lengths. Start-up is expected for early 2020.

The project consists of a complete bar handling arrangement from cold shear to product unloading, which includes a 600

**Cold shear and roller table for bar mills**  
(Picture: Primetals Technologies)



t (660 short ton) cold shear, a cold shear run-out table, gauge beam, short bar handling system, bar counting equipment, bundle forming equipment, bundle tying and bundle storage. In addition, Primetals Technologies will supply an optical bar coun-

## Nucor to build new plate mill

**Nucor Corporation has announced plans to build a state-of-the-art plate mill in the U.S. Midwest.**

Nucor's Board of Directors has approved an investment of 1.35 billion USD to build the

ter with positional layer separation, electrical equipment, automation and installation engineering.

Vinton Steel LLC is a 270,000 t/year mini-mill that uses EAF technology to produce various lengths of rebar in sizes for

the construction industry. Founded in 1962, the company was acquired in December 2016 by Kyoei Steel Ltd. of Japan.

■ *Primetals Technologies*

## Nucor Marion brings on stream new walking beam furnace

**Nucor Steel Marion, based in Marion, Ohio, has successfully commissioned its new walking beam furnace supplied by SMS group.**

The furnace was installed in the existing bar mill. It is designed to deliver 110 t/h

(120 short tons per hour) of hot billets at 1,235°C. The furnace features the SMS-developed Zero Flame burners. The NO<sub>x</sub> content is close to 25 ppm. With less than 0.5 wt%, scale loss is significantly lower than the guaranteed value of 0.75 wt%. With this, Nucor operates the most energy-ef-

icient furnace with the lowest emission values achieved within the Group. SMS group has already received the final acceptance certificate for the furnace.

■ *Nucor*

■ *SMS group*

## Nucor-Yamato Steel to upgrade rolling mill

**Nucor-Yamato Steel Company (NYS) has selected SMS group for the replacement and upgrade of rolling equipment at their heavy section mill in Blytheville, Arkansas.**

Nucor-Yamato Steel is comprised of two rolling facilities commonly referred to as Mill 1 and Mill 2, and capable of producing

2.4 million t/year of finished product. SMS group will upgrade Mill 2, which produces large wide flange and H-pile sections. The core of the upgrade is the substitution of the UR-E and UF stands with a modern tandem-reversing mill type CCS 1500. "The upgrade will allow Nucor-Yamato to expand our production capabilities and include new high-strength steel grades," said

Thad Solomon, vice president and general manager of Nucor-Yamato Steel. SMS group will supply the mechanical equipment and the mill control automation. The start-up of the new tandem reversing mill is planned for the second half of 2020.

■ *SMS group*

## Nucor Steel Tuscaloosa to revamp plate mill

**Nucor Steel Tuscaloosa has selected Primetals Technologies to upgrade its plate mill in Alabama. The project includes a new downcoiler and a Level 1 automation upgrade.**

Nucor Steel Tuscaloosa is one of three plate mills operated by Nucor Corpora-

tion. The upgrade will enable this facility to produce heavier line pipe gauges for the energy industry. The project is scheduled for completion in the first quarter of 2020. The downcoiler will be capable of handling 32-mm-thick low-carbon-grade steel and 25-mm-thick line pipe grades, at up to 2,600 mm wide. Primetals Technologies'

scope of supply also includes runout tables, a new coil handling area, inspection line with shear, hydraulics, banders, markers and an upgrade to the Level 1 automation system.

■ *Primetals Technologies*

## California Steel places order for hot strip mill and galvanizing line upgrade

**California Steel Industries (CSI) has contracted with Primetals Technologies for two electrical and automation projects for its 2,180-mm wide hot strip mill and No. 2 continuous galvanizing line in Fontana, California.**

Following an earlier Level 1 and Level 2 upgrade, the scope of the hot strip

mill project includes a detailed migration plan for new motors, drives and power distribution for six finishing mill stands. Primetals Technologies is supplying medium voltage motors, medium voltage drives, transformers and switchgear, as well as engineering and commissioning. When completed, the upgraded mill will

enable CSI to expand its product mix, minimize delays and improve mill utilization. The electrical and automation upgrade of CSI's No. 2 continuous galvanizing line will be implemented in multiple phases. It will improve mill utilization by replacing equipment nearing obsolescence, including AC and DC drives,

Level 1 automation, Level 2 automation and HMI. The project scope also includes engineering and commissioning. The continuous galvanizing line upgrade is scheduled for a mid-2020 completion,

and the hot strip mill project is expected to be complete by mid-2022.

| *Primetals Technologies*

### Asia: China

## Nantian Tool Steel produces first ingot in new remelting furnace

**Nantian Tool Steel has started production in the first of two new ESR furnaces supplied by INTECO.**

In 2017, the family owned business Nantian Tool Steel located in Huangshi had awarded INTECO with the design and supply of two ESR furnaces, 8 t and a 16 t. These latest-generation furnaces are designed for high-quality, repeatable and most economical ESR production in static mould, single electrode operation. The first heat in the 8 t ESR furnace was produced very smoothly, providing an ingot of very good quality. Hot commissioning of the 16 t furnace will follow shortly.

| *INTECO*

## Shougang Jingtang orders continuous pickling line for second construction phase in Caofeidian

**Primetals Technologies will supply a continuous pickling line to Shougang Jingtang United Iron and Steel. The new line is part of the second phase of a new production plant in Caofeidian, Hebei province.**

The line will be designed to process around 1.5 million t/year of hot rolled strip of ultra-high strength steel (UHSS) grades for products to be used in automotive construction and for all heavy industrial applications. Shougang Jingtang is part of the Shougang Group, which is one of the leading steelmakers in China, with a production amounting to 27.6 million t of steel in 2017. The company operates a number of continuous pickling, annealing and galvanizing lines, processing the complete range of carbon steel, but mainly focusing on value added products like for example automotive exposed and non-exposed quality or appliances.

The pickling line will be designed to pickle hot rolled strip with thicknesses ranging

from 0.8 to 6.0 mm (7.0 mm in the future), and widths from 750 to 1,650 mm, and handle coils weighing up to 33.6 t. Pickling will run at 320 m/min. Primetals Technologies is responsible for engineering, manufacturing and supplying all core equipment for the line. A heavy scale breaker will be installed upstream of the pickling station, which has five flat turbulent pickling tanks fitted with an acid recirculating system. Downstream there is a rinsing tank with five compartments, water recirculation system and strip drier. From here, the strip will pass through a skin-pass mill and a tension leveler. Primetals Technologies will also supply the electrical and automation equipment and provide supervision of erection and commissioning. Shougang Jingtang will take care of the associated civil works and the erection of the line, which is slated for start-up at the end of 2019.

| *Primetals Technologies*



Remelted ingot produced in the ESR furnace (Picture: INTECO)

# MADE IN GERMANY

## Heavy Duty Magnets

Complete product range and tailored solutions for Heavy Duty Magnets.

Design, Manufacturing, Commissioning, Overhaul, Maintenance, Spare Parts.



**WOKO Magnet- und Anlagenbau GmbH**

Theodor-Heuss-Strasse 57  
47167 Duisburg  
Germany

Phone +49 203 48275.0  
Fax +49 203 48275.25  
woko@woko.de  
www.woko.de

## Henan Jiyuan orders rolling equipment for new SBQ mill

**Special steel producer Henan Jiyuan Iron & Steel Co., Ltd. has placed an order with Kocks for a reducing and sizing block for its new special bar quality (SBQ) rolling mill.**

The RSB® 300++/4 is the second block Friedrich Kocks is going to supply to Jiyuan

after the successful installation and operation of a Kocks RSB® 370/4 in 2008. The newest generation RSB® 5.0 is designed for thermomechanical rolling and will finish all straight bar sizes of 12 to 42 mm diameter onto the cooling bed. The roll shop for the preparation of the three-roll stands

and the three-roller guides, and supervision services are also included in Kocks' scope of supply. Commissioning is scheduled for the second quarter of 2020.

■ *Friedrich Kocks GmbH & Co KG*

## Beiman Special Steel to build new wire rod mill

**Beiman Special Steel has signed a contract with Primetals Technologies for a high-speed wire rod mill to be built in Qiqihar, in the province of Heilongjiang.**

The new single-strand wire rod mill will include a high-speed rod outlet with a pre-finishing mill, a no-twist mill, reducing/sizing mill, intelligent pinch roll and high-speed laying head (all Morgan systems). A Stelmor cooling conveyor, a stepless reform system and a vertical coil handling system will complete the 500,000 t/year mill. Output speeds will reach 115 m/s. The start-up is scheduled for mid-2019.

■ *Primetals Technologies*

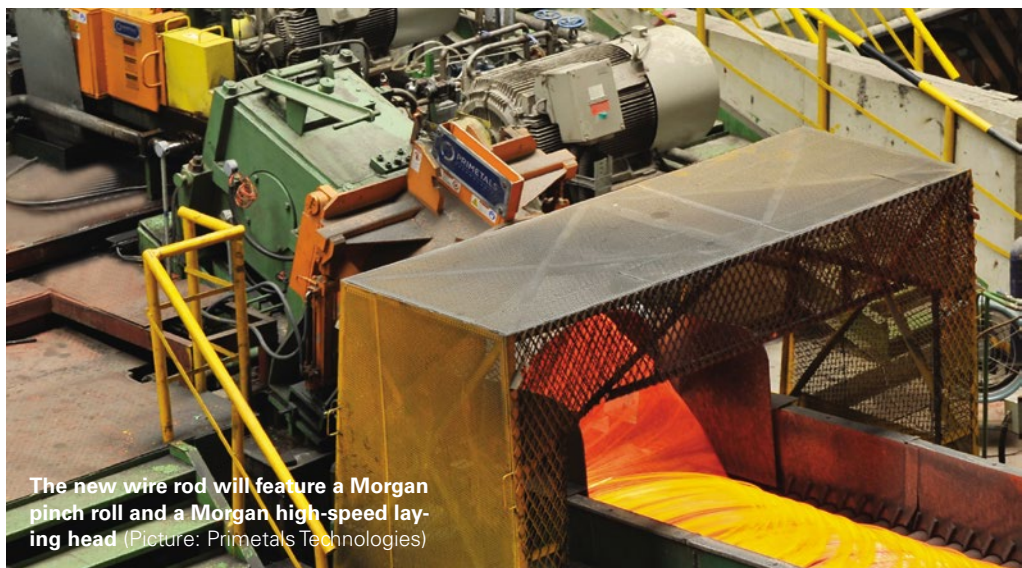

## Nanjing Iron and Steel to upgrade continuous bloom caster

**Nanjing Iron and Steel has awarded SMS Concast AG the order to upgrade the four strands of the continuous caster CCM4 at the Nanjing No. 2 plant.**

With the upgrade Nanjing intends to increase production to more than 800,000 t/year of blooms, while improving product quality and productivity. The four-strand continuous casting machine with a nominal radius of 12 m casts two bloom section sizes: 250 mm x 300 mm and 320 mm x 420 mm.

The casting machine will be equipped with latest technology for dynamic mechanical soft reduction (DMSR). A real-time solidification model will dynamically calculate the temperature profile along the entire strand as well as the roll gap and the reduction forces in the respective modules of the straightening unit. Spray cooling is also dynamically adjusted in accordance with the calculated cooling profile. The upgrade will include further technological and digital solutions

such as a Conflow tundish stopper mechanism, the INVEX® mould technology and a hydraulic tandem oscillation system. The electromagnetic mould and final stirrers and an SMS Concast-developed tool for modulated wave stirring optimize stirring efficiency and save energy. The project is scheduled to be concluded by the end of 2019.

■ *SMS group*

## Rizhao Baohua to install continuous hot skin-pass and tension levelling line for black coil

**Rizhao Baohua New Material is going to install a continuous hot skin-pass and tension levelling line (CHSPM) at its production facility in Rizhao, Shandong province. The equipment will be supplied by Primetals Technologies.**

The line is to process black coil with good flatness characteristics and ease down-

stream tube fabrication and welding for applications in the construction and pipe industries. The CHSPM line will be designed to process 1.2 million t/year.

Primetals Technologies is responsible for the process supply of the line especially designed for the processing of incoming black coil. The scope includes engineering,

manufacturing, and commissioning. The complete drives and automation technology for the line is also part of the project, ensuring seamless and harmonized operation of all components. Specifically, the line will come with a double coil charging and entry section design for heavy incoming black coils, a 6-strand horizontal looper, a

skin-pass mill with a maximum roll force of 1,500 t, a 60-t tension leveller, inspection facilities and an exit and coil dispatching system. The line will be designed to process strip with thicknesses ranging from 0.6 to 4 mm and widths between 900 and 1,600 mm at a process speed of 370 m/min. The maximal coil weight is 35 t.

■ *Primetals Technologies*

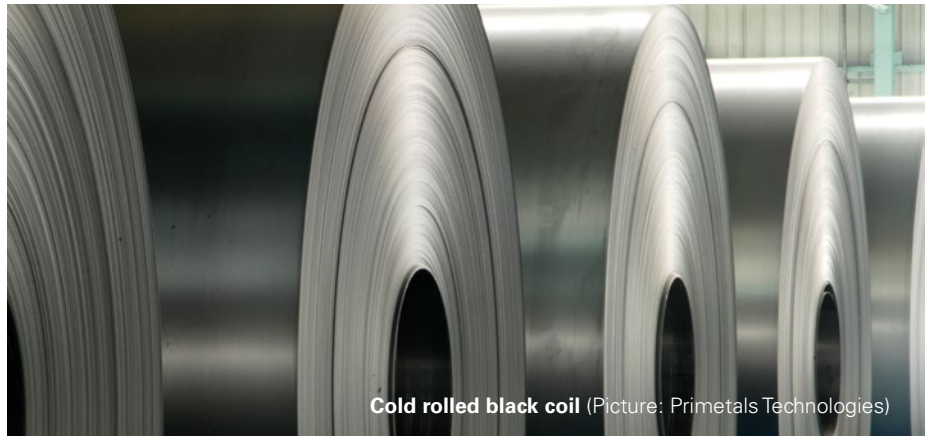

Cold rolled black coil (Picture: Primetals Technologies)

## Weifang Special Steel places order for second reducing and sizing block

**Chinese special steel producer Weifang Special Steel has placed another order with Friedrich Kocks for a reducing and sizing block (RSB®) in 5.0 design.**

This is the second order from Weifang Iron & Steel to Kocks within four months.

Weifang is headquartered in the province of Shandong and mainly produces carbon steel wire rod, welding wire and SBQ for the automotive industry. The Kocks RSB® 5.0 will be used for various SBQ grades such as bearing and spring steel for a diameter range from 18 to 60

mm and a maximum speed of 18 m/s. Commissioning is scheduled for the mid of 2019.

■ *Friedrich Kocks GmbH & Co KG*

## Chengde Steel orders process lines for new cold strip complex

**Chengde Steel Vanadium Titanium Cold-Rolled Sheets has placed an order with Primetals Technologies to supply a continuous pickling line and a continuous galvanizing line for a new cold rolling and processing plant to be built in the company's location in Chengde, Hebei province.**

The continuous pickling line (CPL) will be designed to process 1 million t/year of cold strip, the continuous galvanizing line (CGL) 410,000 t/year.

The CPL will come with a side trimmer, a scrap chopper and a skin-pass mill featuring a maximum roll force of 1,500 t. Strip thicknesses from 1 to 8 mm may be processed, at widths of up to 1,630 mm. Primetals Technologies is also responsible for the engineering, supply of the electrical and automation systems and supervision of installation and commissioning.

The equipment supplied for the CGL will include a skin-pass mill with a roll force of

up to 1,200 t and a tension leveller. The line will be able to process hot strip with thicknesses between 1 and 6 mm as well as cold strip with thicknesses ranging from 0.5 to 2.5 mm, likewise at a maximum strip width of 1,630 mm. Both lines are scheduled to come on stream in the third quarter of 2019.

■ *Primetals Technologies*

## Jiangsu Shagang to expand ladle furnace capacity

**Primetals Technologies has received an order from Jiangsu Shagang to supply a third twin ladle furnace for the converter steelworks in Zhangjiagang.**

This means that a 140 t twin ladle furnace will be added to the two existing 120 t twin ladle furnaces, which were also supplied by Primetals Technologies. The project is scheduled to be completed by the end of the second quarter of 2019. The additional ladle furnace will enable the entire annual production capacity of 2.8 million t of liquid steel to be treated. Also, the new ladle furnace will improve liquid steel quality for use in a continuous casting machine and allow for development of high value added products.

Primetals Technologies will be responsible for engineering the twin ladle furnace and supplying key components. The scope of supply also includes the associated electrical and automation equipment, such as the Melt Expert electrode control system and associated Level 2 models. Primetals Technologies will also supervise installation and commissioning, and train the customer's staff.

■ *Primetals Technologies*



Twin ladle furnace in operation (Picture: Primetals Technologies)



Steelmaking in the EAF Quantum (Picture: Primetals Technologies)

## Langxi County Hongtai to install electric arc furnace and ladle furnaces

**Primetals Technologies is going to supply an electric arc furnace and a ladle furnace for Langxi County Hongtai Steel's plant in Xuancheng, Anhui province.**

For the new EAF Quantum electric arc furnace and the twin ladle furnace, Primetals Technologies will supply the complete mechanical and electrical process equipment and the automation technology, also for the scrap yard management, the charging process and oxygen injection. Also the Level

2 automation will be provided by Primetals Technologies.

The EAF Quantum furnace will be designed to handle scrap steel of varied composition and quality. Scrap preheating reduces the electrical energy requirement of the furnace. The new furnaces are scheduled to be commissioned in the third quarter of 2019.

■ *Primetals Technologies*

## Dongfeng Forging orders eccentric forging press

**Dongfeng Forging has placed an order with SMS group for the supply of an eccentric forging press with a forging force of 5,000 t for its plant in Shiyan, Hubei province.**

Founded in 1969, Dongfeng Forging, which is part of the commercial vehicle manufacturer Dongfeng Motor Group, operates a total of 26 forging lines at this site including, among others, a 12,000 t wedge press supplied by SMS group.

Dongfeng Forging intends to use the new press to manufacture light-truck crankshafts with a maximum finished part weight of 21.5 kg. In addition to the press, the scope of supply includes process development services, sequence-controlled loading and unloading belt conveyors, an electrically oper-

ated automatic walking beam for parts handling, and an integrated die spraying system. SMS group will also supply a line control system for connecting other equipment units as, for example, the heating system.

The MP 5000 is one of SMS group's advanced series of eccentric forging presses. Extremely large press windows in the FEM-optimized press housing offer a perfect automation capability and allow for easier changes of the die and the die holder. The automatic ram adjustment device enables a ram adjustment of 0.1 mm between two strokes. Commissioning of the new MP 5000 forging press is scheduled for the second quarter of 2020.

■ *SMS group*



Eccentric forging press as to be supplied to Dongfeng Forging (Picture: SMS group)

## Changzhou Eastan brings on stream VD plant and continuous bloom caster

**Changzhou Eastan Special Steel has successfully brought on stream a twin vacuum degassing plant (VD) and a continuous bloom caster supplied by Primetals Technologies.**

Primetals Technologies designed all the mechanical and electrical equipment for the 75 t VD plant, and supplied core components, including the vacuum pump, filters and gas cooler. The vacuum pump itself was manufactured in Germany and procured from Leybold. The system was integrated in a Leybold workshop in Tianjin. The vacuum treatment reduces the hydrogen content to less than 1.3 ppm

and the nitrogen content to less than 50 ppm.

The five-strand continuous bloom caster is designed for an annual production of 800,000 t of steel for applications in the automotive industry. It is equipped with a curved pipe mould. The machine radius is 10 m and the metallurgical length around 20 m. It casts high-carbon steels at speeds from 1.05 to 1.5 m/min and produces blooms with a square cross-section of 200 mm x 200 mm. Production can be extended to include other rectangular and round cross-sections. Primetals Technologies was responsible for the basic and detailed engineering, as well as for manufac-

turing moulds, oscillators and segments. Primetals Technologies installed a number of technology packages to ensure not only a trouble-free casting process, but also blooms with high surface and interior quality. The packages included the DynaFlex mould oscillator and straightening units with DynaGap soft reduction. Primetals Technologies also supplied the systems for the basic automation (Level 1) and parts of the process automation (Level 2), and supervised the installation and commissioning of the continuous caster.

■ *Primetals Technologies*



## Sichuan Liuhe Forging to install open-die press with radial forging tool

**Sichuan Liuhe Forging Co., Ltd., based in Jiangyou in the province of Sichuan, has placed an order with SMS group to supply a high-speed, 50/55 MN open-die forging press. The press will be of the two-column, push-down design and feature a table shifter and die shifting unit.**

The open-die forging press operates with a press force of up to 50 MN and a maximum upsetting force of 55 MN. The press is suited for forging high-quality products with finished dimensions within a tolerance range of  $\pm 1$  millimeters.

The order also includes an X-Forging Box 650/50 MN, which is a newly developed radial forging tool for open-die forging presses. The X-Forging Box transforms the movement of the top tool in the open-die forging press into a radial movement of the four tools in the X-Forging Box. At the same time, the maximum permissible force of 50

MN is evenly distributed among the four tools. The maximum initial pass section is 650 millimeters. The box is capable of forging a wide range of high-quality round products with variable cross-sections, enabling Liuhe Forging to expand its product mix and quickly change between different types of products. No modifications to the tool chamber or to the hydraulic-electrical connections are required to install the box. Commissioning of the forging press and the X-Forging Box is scheduled for the fourth quarter of 2019.

Sichuan Liuhe Forging is a specialist manufacturer of forged semi-finished products, reinforcing rings, shafts, parts for turbine blades, and supercritical components for gas turbines made of high-temperature, corrosion-resistant special steel and superalloys.

**| SMS group**



The 50/55 MN open-die forging press in two-column design will come with an X-Forging Box (Picture: SMS group)

**J**

# JASPER

Setting The Standards For Highest Efficiency In Thermal Processing

**THERM PROCESS** Hall 10  
Booth A11

**JASPER**  
Gesellschaft für Energiewirtschaft und Kybernetik mbH / Bönninghauser Str. 10 / D-59590 Geseke  
Telefon: +49 2942 9747 0 / Fax: +49 2942 9747 47 / [www.jasper-gmbh.de](http://www.jasper-gmbh.de) / [info@jasper-gmbh.de](mailto:info@jasper-gmbh.de)

PulsReg® Zentral Regenerator, 12 MW

## HBIS Laoting orders another continuous slab caster

**Chinese steel producer HBIS Laoting has ordered another two-strand continuous slab caster from Primetals Technologies. The casting plant will form part of a new production facility for high-quality steels, which is being built in the Laoting district in the south east of the autonomous city of Tangshan.**

HBIS Laoting had already ordered two slab casters from Primetals Technologies in 2017. They will start operation in the course of this year. The now ordered third continuous slab caster is scheduled for commissioning in February 2020.

The new two-strand continuous slab caster will be designed for a production capacity of 2 million t/year and have a machine radius of 9.5 m and a metallurgical length of 35.1 m. It will cast slabs with a thickness of 230 mm in widths ranging from 800 to 1,600 mm. The maximum casting speed will be 1.8 m/min. The range of products will cover ultra-low carbon and low carbon steels, deep drawn, structural peritectic alloyed steels, and pipe grades.

Primetals Technologies is responsible for the detail engineering of the casting platform and the strand-guiding system, the

basic and detail engineering of the maintenance area, as well as the engineering of the automation and the software for the new continuous slab caster. The scope of supply includes the complete electrical installations and automation, as well as core components, such as mould and mould oscillator, bender and Smart Segments for the strand-guide system. Primetals Technologies will also supervise the installation and commissioning, and conduct the customer training on site.

| *Primetals Technologies*

## Hunan Valin awards reducing and sizing block order for SBQ greenfield mill

**Special steel producer Hunan Valin is going to use a Kocks reducing and sizing block in its new greenfield special bar quality rolling mill No. 3.**

The Kocks RSB® 370+ +/5 of the latest 5.0 design will be designed for ther-

mo-mechanical rolling and for finishing all straight bar sizes in diameters ranging between 16 and 100 mm onto the cooling bed. Friedrich Kocks will also supply the roll shop for preparing the three-roll stands and the three-roller guides. Commissioning of the Kocks

block is scheduled for the first quarter of 2020.

| *Friedrich Kocks GmbH & Co KG*

### Asia: India

## Mukand Sumi Special Steel to install SBQ mill

**Mukand Sumi Special Steel Ltd. (MSSSL), a joint venture of Mukand Ltd., India, and Sumitomo Corporation, Japan, has placed an order with SMS group for the supply of a state-of-the-art special bar quality (SBQ) rolling mill for the production of straight round and hexagon bars, wire rod and bar-in-coils.**

The new mill will be installed near Hospet in Karnataka, adjoining Mukand's existing steelmaking facilities. Mukand and Sum-

itomo Corporation are aiming to export specialty steels across the globe from this unit. In a first stage, the mill will have an annual capacity of 400,000 t, but will already be prepared for a capacity increase to 600,000 t/year in a second stage. The mill will include a walking-beam reheating furnace, 18 housingless two-high stands in H/V arrangement, a precision sizing mill (PSM®), shears, cooling lines, cooling bed with finishing facilities, a wire rod line with a ten-stand wire rod block, coil han-

dling equipment and a coil compactor. The heart of the mill is an advanced three-roll PSM® with hydraulic roll adjustment under load. The layout of the wire rod outlet will also consider a future upgrade with a MEERdrive®PLUS sizing block. A pouring reel line with two coilers specially designed for scratch-free guiding of finished products will complete the mill.

| *SMS group*

### Asia: Japan

## JFE Chita orders further threading machine for large pipes

**SMS group has received a new order from JFE Steel Corporation for a premium threading machine. The machine will be installed in JFE's Chita works in the Chukyo Industrial Zone.**

Threading machine operating according to the rotating pipe principle (Picture: SMS group)



The new machine, the second threading machine supplied by SMS group to JFE, will be designed to thread pipes in the diameter range from 139.7 to 406.4 mm with wall thicknesses from 7.0 to 50.8 mm and lengths of up to 15 m. The type TCG 43/4 machine operates according to the

“stationary tool – rotating pipe” principle. With this method it can cut standardized inside and outside threads as well as all premium threads. Thanks to latest FMEA (failure mode and effects analysis) technology and temperature control, the machine has excellent stability and produces threads

of highest quality. The pipe threads comply with the production standards for all API 5CT steel grades, JFE grades and other international standards.

■ SMS group

## Asia: Pakistan

### Naveena Steel to build mini-mill

**Naveena Steel Mills (Private) Limited has awarded Primetals Technologies an order to supply a continuous billet casting machine and a bar rolling mill for a new mini-mill in Port Qasim, Karachi.**

With the new mini-mill, Naveena Steel, founded in 2018, will be able to respond to the growing steel demand expected from the infrastructure development in Pakistan. The mini-mill will produce around 270,000 t/year of reinforcing steel (rebars) with diameters ranging from 8 to 40 mm. Commissioning is scheduled to start in the second quarter of 2019.

The billet caster will be supplied by Concast (India) Ltd., a Primetals Technologies group company. It will consist of two strands, with provisions made to add a third strand in the future. The caster has

a curved tube mould, and is a multiple-radius machine, with a basic radius of 6 m and a second radius of 11 m. Maximum casting speed is 4 m/min. Concast (India) is responsible for designing, engineering and manufacturing the ladle support, tundish and tundish support, mould and oscillator, straightener segments, secondary cooling, dummy bar system as well as pusher and cooling bed. The company will also supply the basic automation (Level 1) and HMI system. The caster will produce the starting material for hot charging into bar rolling mill.

The rolling line will consist of a furnace discharging area, a 6-stand roughing mill, a 6-stand intermediate train and a 4-stand finishing train. All rolling stands will be of the Red Ring Series 5 design. The rolling mill will also include an inline PQS quenching system and a 54-m-long cooling bed,



**A PQS inline quenching system will be integrated into the new mini-mill for rebar production** (Picture: Primetals Technologies)

extendable to a total length of 66 m at a later stage.

■ Primetals Technologies

## Asia: South Korea

### Hyundai Steel brings on stream new horizontal roller straightener

**Hyundai Steel has successfully commissioned the new straightening machine from SMS group.**

SMS group has received the FAC for the new horizontal roller straightener installed

at Hyundai Steel's medium section mill in Incheon. The new machine replaces a more than twenty-years-old straightener. With the new equipment, Hyundai Steel is able to roll larger sheet piles and beams up to a web height of 450 mm. In addition to extending

the product range, the straightener helps to improve the tolerances and quality of the sections.

■ SMS group

## Ulsan Aluminum upgrade rolling mills with new automation technology

**South Korean aluminium producer Ulsan Aluminum is going to upgrade its hot rolling mill and its cold rolling mill No. 2 with new automation technology from Primetals Technologies.**

Ulsan Aluminum Ltd. was founded by Novelis and Kobe Steel as a joint venture company in 2017. The Ulsan plant produces rolled aluminium plates for the Asian markets of the beverage and electronics industries,

the transportation sector and the construction business. Primetals Technologies will supply a new automation system for the hot rolling mill, including the automation platform, technological control systems, for example automatic gauge control, hydraulic gap control, work roll bending, as well as the data acquisition and the associated operator control and monitoring system.

Cold rolling mill No. 2 in the Ulsan plant will be equipped with a similar technol-

ical control system as the hot rolling mill. Here again, the scope of delivery includes the data acquisition and the associated operator control and monitoring system. Primetals Technologies will be responsible for the installation, commissioning and fine adjustment of the automation technology in both rolling mills.

■ Primetals Technologies

**Asia: Thailand****Siam Yamato Steel introduces robotic system in meltshops**

Robotic system in operation (Picture: Danieli)

**Siam Yamato Steel Thailand has migrated to no-man operation with robotics solutions from Danieli Telerobotlabs.**

Siam Yamato Steel Thailand, specialized in high quality finished long products, has chosen Danieli, and in particular Danieli Telerobotlabs, as main partner in the migration process to robotics, taking a fundamental step towards Industry 4.0. Two robotized solutions have already been implemented in the two EAF meltshop areas of Siam Yamato Steel's Rayong plants. The robotized systems, introducing so called "no-man operation," went into operation in January 2019.

**| Danieli**

**Europe: Austria****CC8 slab caster of voestalpine Stahl achieves nominal production capacity**

**voestalpine Stahl has integrated a new slab caster (CC8) into the No. 3 LD meltshop of its Linz steelworks.**

The Danieli-supplied CC8 slab caster replaces the former CC3 caster at voestalpine Stahl in Linz. Commissioned in Oc-

tober 2018, the caster has been operating at its nominal monthly production rate of 100,000 t. During the first months in operation, the machine has proved its reliability by casting 101 heats in a sequence with 16 flying tundish changes. These results have confirmed the quality and reliability of the mechanical equipment and technological packages provided by Danieli in synergy with the experience and knowledge of the voestalpine Stahl staff. Thanks to the efficient tuning of the operating practices, voestalpine Stahl's internal quality standards were easily reached and the CC8 slab caster successfully and completely integrated into voestalpine Stahl's No. 3 LD meltshop.

**| Danieli**



CC8 continuous caster at voestalpine Stahl soon reached its nominal production (Picture: Danieli)

**Europe: Czech Republic****Trinec Iron and Steel grants FAC for upgraded blooming mill**

**SMS group has received the final acceptance certificate (FAC) from Trinec Iron and Steel for the upgraded blooming mill.**

The objectives of the upgrade were to maintain and ensure the operational reliability and plant availability, create the necessary process stability and improve quality, tolerances and yield. The scope

of the upgrade included a new ultra-rigid two-high reversing blooming mill stand with shifting unit and hook-type tilter. The blooming mill is used for the preshaping of intermediates – also of high-alloy steels – made from continuously cast material of up to 525 mm in diameter and ingots up to a weight of 5.3 t. Moreover, it also provides the feedstock material for the existing rail,

bar and wire rod production at Trinec Iron and Steel. Another core element of this project was the new hydraulic bloom shear with a shear force of around 1,000 t, driven by an innovative and energy-efficient variable-speed pump.

**| SMS group**

## Trinec Iron and Steel introduces tundish lining robot

**Trinec Iron and Steel has introduced a robotic process for applying refractory mass to the continuous casting tundish. The complete management system for the tundish maintenance operations, including the control of the robot, was developed by the staff of the steel mill.**

“Putting the robot into the tundish maintenance area under harsh metallurgical conditions is quite unique,” explains Cezslav Marek, production manager of Trinec

Iron and Steel. The benefit of this application lies primarily in improving the working conditions for employees, removing hard work in manual spraying, shortening the application cycle and achieving a high degree of uniformity over the entire inner surface of the tundish lining. As a result, the service life of the tundish increases and resources are saved.

Trinec Iron and Steel



Robotic tundish lining process developed by steel mill team of Trinec Iron and Steel (Picture: Trinec Iron and Steel)

## Europe: Finland

### Ruukki Construction to become a majority shareholder in Piristeel Oy

**SSAB's subsidiary Ruukki Construction has agreed to acquire a majority holding of 67% in the Finnish company Piristeel Oy.**

Piristeel Oy is Finland's leading manufacturer of roof safety products and rainwater systems. The transaction supports Ruukki Construction's growth strategy for the roof-

ing business, at the same time improving SSAB's position in the Nordic home market. The transaction is expected to be completed in the first quarter of 2019.

# G|S|B

## Group

*newthink!*

- Silica Bricks
- High Alumina, AMC, ASC Bricks
- MgO, MgO-C & MgO-Chrome Bricks
- Spinel Bricks
- Precast Shapes
- Monolithic Lances
- RH Degasser Refractories
- Isostatic Products
- Complete Ladle Solutions

A **Dalmia OCL** Company  
info@gsb-group.de



Established by Pentti and Ritva Piri in 1989, Piristeel Oy has around 70 permanent employees at three production facilities in Kauhava and Lapua. During 2019, the company will concentrate production on one production facility

in Kauhava. Under the transaction, the current owners will for the time being retain a minority stake (33%) and continue to work for the company. Ruukki Construction has an option to acquire the remaining part of the company. The

company will continue to trade under its own brand as part of Ruukki Construction.

| SSAB

## SSAB Europe brings forward maintenance work at blast furnace 2 in Raahe

**In the wake of the minor break-out in blast furnace 2 at SSAB's Raahe site in January 2019, SSAB Europe will now carry out repairs and maintenance work at the furnace.**

After the incident, the blast furnace was stopped temporarily and an extensive anal-

ysis of the condition of the blast furnace was initiated. The conclusion from the analysis is now that, aside of the repairs, maintenance work planned for the summer of 2020 will be brought forward to reduce the risk of further disruptions. This means that the operations at blast furnace 2 will be stopped for around eight weeks in total. The

production loss will partly be compensated by the other blast furnaces of SSAB Europe and by the blast furnaces of SSAB Special Steels in Oxelösund, or, if necessary, by sourcing external slabs.

| SSAB

### Europe: France

#### Laminoirs des Landes places dividing shear order

**Danieli will supply a hydraulic dividing shear for the plate mill of Laminoirs des Landes for high-precision cutting of thick and thin plates.**

Steel plate producer Laminoirs des Landes has selected Danieli for the sup-

ply of a new hydraulic hot shear to be installed in Tarnos. The new shear will allow Laminoirs des Landes to cut hot plates (600 – 900°C) of up to 50 mm thickness and widths of up to 3,500 mm. Thanks to the knife-angle and knife-gap adjustment systems, the machine allows thick and

thin products to be cut with the same excellent performance. The new hydraulic shear will be put into operation in early 2020.

| Danieli

### Europe: Germany

#### Musashi Europe places order for 5,000 t eccentric press

**SMS group will install a 5,000 t eccentric forging press, type MT 5000, at the Bockenau location of Musashi Europe. The press will produce large rotationally-symmetric forgings for passenger cars and truck applications.**

Commissioning of the new eccentric press for Musashi Europe is scheduled for the fourth quarter of 2019 (Picture: SMS group)

The MT 5000 is one of the latest generation of eccentric presses from SMS group. With the new eccentric forging press, which features a MEERtorque® servo drive, forging is precise, reliable and fully automatic. The eccentric shaft and the flywheel are directly driven by dynamic torque motors. This type of drive separates the pure ram motion from the forging energy supply, and combines the advantages of servo presses with those of presses featuring a flywheel and conventional clutch-brake combination. This means the forging process is both highly energy-efficient and resource-friendly. The energy generated during the deceleration phase can be used for the re-acceleration of the flywheel.

Thanks to the reduced number of mechanical components, Musashi Europe benefits from considerably lower maintenance and inspection costs. What's more, sections of the MT press casing can be easily opened to offer the best possible access. Furthermore, the utilities are supplied via a central energy column, which also provides particularly maintenance-friendly access.

The construction of the robust, FEM-optimized press housing is based on the proven split tie-rod design. Extremely large press windows offer perfect automation capability and allow for easier changes of the die and holder. To enable individual dies to be replaced, the MT 5000 is equipped with a die change arm, which is fitted to the press housing. The integrated die spraying system cleans, cools and dries the dies in precise doses to achieve maximum forging quality and increase the service life of the dies.

| SMS group



## Stahlwerk Thüringen to upgrade section mill with universal mill U1

**Stahlwerk Thüringen GmbH, a company of Brazilian Grupo CSN, has selected SMS group for the supply of a new CCS® (compact cartridge stand) universal stand U1 for its section mill in Untertwellenborn.**

As a result of the continuously growing range of sections produced, especially to include increasingly heavier and larger section sizes, Stahlwerk Thüringen has decided to replace the existing U1 stand in operation since 2002 as breakdown stand for the three-stand CCS® tandem group. The new stand will be designed for a nominal rolling force of 6,000 kN horizontal and 4,000 kN vertical. It will come with stronger roll guides and optimized roll cooling.

The scope of the modernization also comprises the supply of a new control system (TCS) based on the X-Pact® automation system for the complete CCS® tandem group and adaptation of existing control systems. In addition to the upgrade of the hardware and the system software, the I/O level for the U1 will be newly set up. Last but not least, all screwdown systems will be controlled by a newly developed dynamic optimization system. Commissioning is slated to take place in August 2019.

| SMS group

## Georgsmarienhütte commissions new profile gauge

**Georgsmarienhütte (GMH) has successfully commissioned a full profile measurement gauge from Friedrich Kocks.**

The Kocks 4D EAGLE® gauge replaces a light measurement gauge at the exit of the existing Kocks RSB® 370/6. The new gauge, working based on the laser light sectioning method, covers a production diameter range from 19.5 to 82.3 mm. Apart from increasing the reliability and consistency of hot bar profile measurements, the gauge provides profile data to the RSB® size control system (SCS®) for closed-loop process control. The rolling defect detection feature enables auto-recognition of form deviations as well as rolling defects.

| Friedrich Kocks GmbH & Co KG



The product portfolio of Stahlwerk Thüringen includes heavy and large sections (Picture: Stahlwerk Thüringen)

**RUMP STRAHLANLAGEN**

**50 Jahre**  
1969 - 2019

**25.-29.06.2019**  
Düsseldorf  
Hall 15  
Booth 15E24

**GIFA**

**RUMP STRAHLANLAGEN**  
GmbH & Co. KG [www.rump.de](http://www.rump.de)

RUMWA-BI 02809112119

## Hydro Aluminium Hamburg operates with DanJoint drive spindles



Representatives of Hydro Aluminium Hamburg inspecting the new spindles (Picture: Danieli)

**Thanks to new drive spindles supplied by Danieli, Hydro Aluminium Hamburg now achieves a markedly higher force transmission factor in hot rolling.**

At the end of 2017 Hydro Aluminium Hamburg, a subsidiary of Hydro Norsk Group, awarded Danieli Service the contract to study and carry out the upgrading of two existing grease-lubricated slipper-type spindles for the hot-rolling mill at that location.

Hydro received two new DanJoint spindles, weighing approximately 35 t each and for the first time equipped with a fully integrated online torque measurement and temperature control device. These slipper-type spindles are equipped with an air-oil lubrication system, extending the service life by up to 30% and significantly cutting the operating costs. Also the environmental impact is much lower as the loss of lubricants is markedly reduced.

**| Danieli**

### Europe: Italy

## Feralpi to introduce endless rolling in wire rod mill

**Feralpi Siderurgica S.p.A. has placed an order with SMS group for the supply and installation of the EBROS welding technology at its Lonato plant in Brescia.**

The EBROS billet welding system is used to weld together the hot billets as they come out of the reheating furnace. This process makes endless rolling possible, offering a considerable increase in productivity, material yield and plant utilization as well as guaranteeing a consistently high product quality.

Implementing EBROS in the wire rod mill will increase productivity of the Feralpi plant as head and tail end cropping can be eliminated and cobbles prevented. The system for Feralpi comes with an advanced transformer solution to yet better control the welding operations. It includes an easier cleaning system, reduces maintenance and sparks, and provides efficient deburring with a collecting bucket and a quick change system. A 2 MW induction furnace supplied by SMS Elotherm, a company of

SMS group, will be included in the supply to ensure billet temperature equalization at the entry into stand No. 1.

The machine will exploit the furnace capacity of 130 t/h and weld billets up to 150 mm square and 12 m long to be rolled on the existing mill. Commissioning of the new welding system is scheduled for the first quarter of 2020.

**| SMS group**

### Europe: The Netherlands

## Tata Steel Europe IJmuiden postpones blast furnace revamp

**Tata Steel Europe has decided to postpone the revamp of its IJmuiden blast furnace No. 6, installed in 1986, until after 2021.**

Blast furnace No. 6, which has been in operation at Tata Steel Europe in IJmuiden for more than 30 years, will not be revamped until after 2021. By that time the blast furnace will have produced more than 80 million t of hot metal. Such an extraordinarily

long blast furnace campaign is due to the Danieli Corus blast furnace design with copper plate coolers and high-conductivity refractories.

Blast furnace No. 7, which started its current campaign in 1992, features the same design. This furnace, too, is not scheduled for relining before achieving 30 years of operation.

These long campaigns are particularly impressive as these furnaces operate at

low coke rates (down to 250 kg/t HM) and high productivity rates (3.5 t HM/m<sup>3</sup>WV.24h). This is achieved through ultra-high pulverized coal injection rates of 250 kg/t HM and oxygen enrichment of 15%. Both furnaces have been operating at an availability higher than 98%.

**| Danieli Corus**



## Europe: Russia

### Metalloinvest to overhaul and upgrade blast furnaces

**Metalloinvest has awarded Danieli Corus the contract for a large-scale technical overhaul of its blast furnaces 2 and 3 at the Ural Steel plant in Novotroitsk.**

Danieli Corus will replace the shells of both furnaces along with the furnace lining. In addition, a new automated control system for first and second tier technological

processes will be installed, including the automation of natural gas injection. Both furnaces will retain their current support systems and be equipped with the Danieli Corus cooling and lining system. High-conductivity graphite refractories and copper cooling plates will be installed with the addition of silicon carbide refractories in areas where there is high abrasive wear.

At blast furnace No. 3, a modern Danieli top charging unit with a hydraulics-based chute-type distributor will be installed. The distributor has an extremely small number of moving parts for maximum availability.

**| Danieli Corus**

### MMK to install quality management system

**Magnitogorsk Iron and Steel Works (MMK) has placed an order with MET/Con, an SMS group company, for the implementation of a quality management system.**

MMK produces around 10 million t/year of quality steel at its site in Magnitogorsk. The steel is used in the construction and automobile industries as well as in pipeline and mechanical engineering application. As part of a company-wide Industry 4.0 initiative, MMK will implement the new SMS group's PQA® (product quality analyzer) system in order to further improve quality levels across all processes in Magnitogorsk, as well as stabilize production processes and improve on-time delivery performance.

The PQA® system is a holistic IT solution that operates on know-how based

expert rules. Among other things, the advanced software and database solution from SMS group company QuinLogic is to be used. The modular software structure comprises a LogicDesigner for flexible rule adaptation, a quality assessment module, and a web-based reporting system. The centrepiece of the quality management system is the DataCorrelator software module, which also covers current topics such as big data analyses and artificial intelligence (AI). Various intelligent mathematical evaluation methods, including pattern recognition options, identify and indicate correlations that can be directly used for process optimization.

**| SMS group**

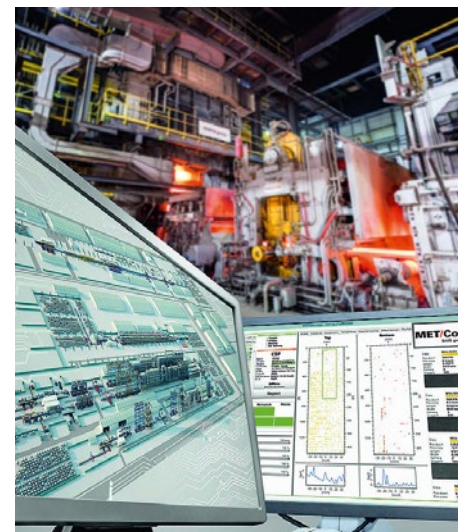

**The quality management system provides transparency across all processes** (Picture: SMS group)

### Mechel launches online store for steel trade

**An online store recently launched by Mechel Service offers a wide range steel articles.**

Over 40,000 articles in 49 categories such as flat products and sections, pipes, hot- and cold-rolled products, hardware,

stainless steel products, etc., are available from Mechel's online store at: [www.mechelservice.ru/catalog](http://www.mechelservice.ru/catalog). The website also shows updated information about Mechel's sales network locations in 41 Russian cities and towns. Any Russian-based client can make a purchase

and choose to use a delivery service or the customer pick-up option. The store's interactive structure is simple and intuitive.

**| Mechel**

### OMK to build new seamless pipe complex

**OMK has contracted Danieli to supply a new pipe complex for the production of oil and gas seamless pipes.**

To be installed at Vyksa Steel Works, the new seamless pipe complex of OMK will produce 500,000 t/year of OCTG seamless pipes (casing and tubing), linepipe and in-

**Layout of the new seamless pipe production line for Vyksa Steel** (Picture: Danieli)

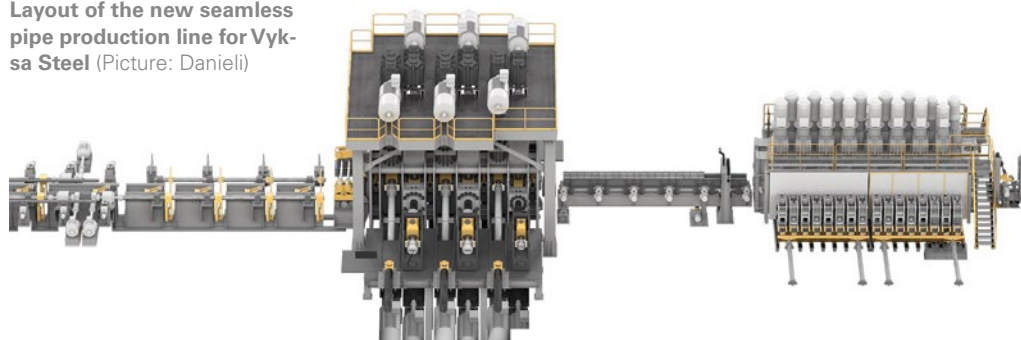

dustrial pipes from 2" 7/8 to 10" 3/4. The plant will mainly consist of a hot rolling line based on the FQT – fine quality train technology and a finishing centre featuring heat treatment, quality assurance and finishing lines.

Danieli will provide plant and equipment engineering, equipment manufacturing, supervision for erection and commissioning, and customer training. All process lines will be equipped with the most advanced Danieli Automation

process control and tracking systems. The new plant is scheduled to be commissioned in 2021.

| Danieli

## Fletcher Group consolidates service functions into Corporate Solutions Centre

### NLMK has sold 100% of its stake in NLMK Accounting Centre to Fletcher Group Holdings Limited.

NLMK Accounting Centre will be used as a platform for setting up a single service company, NLMK Corporate Solutions Centre, that will provide services to NLMK group companies and Universal Cargo Logistics Holding (UCL Holding), an international transport group, including Freight One

(PGK). This transaction will ensure a balance of interests of all the businesses serviced by the new centre. NLMK Corporate Solutions Centre will offer support for corporate functions, including accounting and taxation management, HR document flow, treasury, and procurement processes.

The goal of setting up a single centre for corporate solutions is to improve operational efficiency through standardization and optimization of supporting processes

and control procedures, to introduce best practices, promote IT tools, and establish competence centres.

NLMK Corporate Solutions Centre will be headed by Nelly Mescheryakova, who held the position of NLMK group's director for corporate finance until the end of 2018.

| NLMK

## Europe: Spain

### Fives acquires activities and knowhow from RDI-Met

#### Fives has acquired certain activities of RDI-Met (Spain), a subsidiary of Fagor Arrasate, specialized in steel and aluminium processing and metal stamping.

The acquired activities and know-how include cold rolling mills and strip processing lines

for the steel and aluminium industries. They will complement Fives' activities in the mechanical engineering and supply of processing lines with certain specific terminal equipment for strip processing lines, color coating lines, and degreasing and pickling equipment. The core of the RDI-Met team will be integrated

into Fives' steel subsidiary in Spain which specializes in a wide range of heat treatment technologies for steel products, including the final treatment of coated coils.

| Fives

## Europe: Sweden

### SSAB Oxelösund to build new hot blast stove for blast furnace

#### Danieli Corus is going to supply a new combustion chamber-type hot blast stove for blast furnace No. 4 in Oxelösund.

The new stove for SSAB is an addition to the existing hot blast system which currently comprises four internal combustion

chamber type stoves. The addition of stove 47 will allow for the further modernization of the hot blast system, especially with respect to the older stoves 41, 42 and 43. The scope of the project includes the required modifications to the hot and cold blast mains and other parts of the system. The new stove is scheduled to

be in full operation in early 2020. The Oxelösund plant of SSAB is an integrated steel plant with two blast furnaces and a total production capacity of 1.75 million t/year.

| Danieli Corus

## Europe: Turkey

### Yildiz Lar starts up cold tandem mill

#### As a core part of the new pickling line cold rolling complex in Izmit (Kocaeli), Danieli and Yildiz Lar recently started up the cold tandem mill.

The start-up of the cold tandem mill follows the successful commissioning of the pickling, galvanizing and batch-annealing lines as well as of the temper mill at the new steel complex.

The new five-stand tandem mill is made up of six-high stands featuring Danieli OSRT shaped-roll technology and controlled by a Danieli Automation process control system. An automatic eccentricity compensation algorithm ensures precise and simple control of the strip thickness. The mill produces coils in final strip thicknesses down to

0.2 mm and widths up to 1,550 mm in a product mix including DP600, DP1000, IF and HSLA. The preliminary acceptance certificate was signed just two weeks after the start-up.

| Danieli

## Mechel extends coke export contract

**Russian mining and metals company Mechel has prolonged its agreement on coke supplies to Kardemir.**

According to the agreement, from January to December 2019 Mechel will supply Kardemir with 200,000 t of metallurgical

coke produced at the Moscow coke and gas plant. Compared to the previous deal, the amount of supplies to Kardemir will go up by nearly 70%. Coke will be shipped via Port Mechel Temryuk in Russia's Krasnodar region. The coke price will be determined on a quarterly basis following negotiations.

Turkish companies consume about 6 million t/year of coke, with Turkey's coke producers accounting for approximately 5 million t. The remainder is imported.

■ *Mechel*

## Australia

### GFG Alliance to build structural section and rail mill

**GFG Alliance has selected Danieli for the design and construction of a new high-tech rail and section mill at the Whyalla steelworks.**

The new 750,000 t/year structural and rail heavy section mill will increase the production capacity of the Whyalla steelworks, reduce waste and enable GFG's Liberty Primary Steel to lift product ca-

pability and improve its competitive advantage.

The mill will be equipped with Danieli's patented RH2 process for rail hardening that enhances mechanical properties of high-speed rails through multi-immersion steps into a quenchant. The project will be executed in two phases. The first phase foresees Danieli to work in combination with AAR TEE Ferretti International for turnkey con-

struction and auxiliaries, and the Liberty team to develop the engineering stage.

The second phase will consist of equipment design, manufacturing, supplying and commissioning to reach the goal of hot commissioning in the following 18 months.

■ *Danieli*

# KIRO-NATHAUS GmbH



## → COKE QUENCHING TOWERS

## → EMISSION CONTROL FACILITIES

Systems for separation of dust and water from quenching steam built to our own patents with residue guarantee as per TA Luft

## → FORCED-CIRCULATION COOLER

## → NATURAL DRAFT COOLERS

## → WOODEN STRUCTURES OF ANY KIND

Haus Füchteln 9  
59399 Olfen

Tel: +49 25 95 / 38 77 00  
Fax: +49 25 95 / 38 77 08

mail@kiro-nathaus.de  
www.kiro-nathaus.de

The Bright World of Metals, 25 – 29 June 2019, Düsseldorf, Germany

# Trade fair quartet GIFA, NEWCAST, METEC and THERMPROCESS

Theory and practice go hand in hand at the metallurgical exhibitions in Düsseldorf. International conferences, symposiums and special shows enrich this trade fair quartet. Special emphasis is placed on additive manufacturing.

With 2,000 exhibitors and around 78,000 metalworking professionals expected to attend from around the world, Düsseldorf will once again become a hotspot for international foundry and metalwork technology from 25 to 29 June 2019. Under the slogan "The Bright World of Metals," the trade fair quartet, comprising GIFA, NEWCAST, METEC and THERMPROCESS, covers the entire spectrum both in-depth and with a wide scope, ranging from foundry technology, casting products, metallurgy and thermal processing technology. But what would this international quadruple trade fair be without its extensive supporting programme for experts? The international conferences, symposiums and industry meetings are unique platforms for expertise, bringing theory and practice together and offering an amazing opportunity to network and exchange with other tradespeople.

## Metallurgical trade fair METEC to be staged together with top-class conferences

METEC and its accompanying conferences, the EMC – European Metallurgical Confer-

ence - and the ESTAD – European Steel Technology and Application Days – form an unbeatable trio. The ESTAD, held from 24 to 28 June, focuses on the raw material steel, along with its manufacturing, applications and steel within the context of environmental engineering and energy. For steel manufacturers, suppliers and operators, this five-day conference is an absolute must. Ultimately, this English-speaking conference is split into five topic areas:

- iron production,
- steel production,
- rolling and forging,
- steel materials and their applications, additive manufacturing techniques, surface technology,
- environmental protection and energy.

The 4th ESTAD is organized, in tried-and-tested tradition, by the Steel Institute VDEh (Association of German Steel Manufacturers) in cooperation with its partners, the Austrian Society for Metallurgy and Metals (ASMET) and the Associazione Italiana di Metallurgia (AIM).

METEC is not the only institution that is celebrating a decade in action – the EMC is also celebrating its tenth edition next year. The European Metallurgical Conference is the most important conference for non-fer-

rous metallurgy in Europe and starts two days before the METEC. Its main theme is the optimal use of resources and recycling to provide a sustainable solution. This exclusively English-speaking conference is an invitation from the GDMB (Society of Metallurgists and Miners) and is oriented towards metal producers, equipment manufacturers and service providers, as well as universities and engineering firms. Buy tickets and register from January 2019 via the following link: <https://emc.gdmb.de/registration>.

## THERMPROCESS complete with symposium and special show

Theory and practice are also united at the two THERMPROCESS events, the FOGI special show, from FOGI, the Research Association for Industrial Furnace Engineering in the VDMA (Mechanical Engineering Industry Association) and the THERMPROCESS symposium from VDMA Metallurgy. The symposium illuminates topics that are current within thermal processing technology via a multitude of speeches from experts. The following topics form the main focus of this:

- new combustion technology,
- resource conservation and energy efficiency, with particular attention to CO<sub>2</sub> and NO<sub>x</sub> emission reduction,
- challenges posed by variation in gas quality, specifically when alternative fuels are fed in,
- current and future requirements for thermally treated automotive materials,
- heat treatment concepts in thermal processing technology,
- Industry 4.0 and implementing it in thermal processing technology.

In addition to these speeches, renowned research institutes from the thermal processing technology sector will present their subject areas and current research work in the FOGI special show in Hall 10.



The four international technical exhibitions GIFA, METEC, THERMPROCESS und NEWCAST will occupy 14 halls at the fair ground in Düsseldorf, Germany (Picture: Messe Düsseldorf)

## GIFA & NEWCAST: A firecracker for the foundry industry

The VDG (German Foundrymen's Association) and the BDG (Confederation of German Foundry Industry) ignite a firecracker at GIFA and NEWCAST. The Foundry Meeting in Hall 13 (Stand D 04), which has been re-designed, serves as the main draw throughout the entire run of the trade fair with its different themed areas. In the "Technology in Casting" area, BDG member companies present the entire range of foundry working materials. Marvel at cast components in "World of Castings," which is right next door. Alongside this, high-quality, exciting speeches will also be given on the five days of the trade fair at the BDG forum. Wednesday is dedicated to the foundries, which proffer information on the latest innovations in the foundry industry and outline practical solutions for daily foundry work and routines at the NEWCAST Forum in Hall 13. On 26 June, the day will be topped off with the presentation of the NEWCAST Award for innovative cast parts. The two-day GIFA Forum bookends this event (it takes place on 25 and 27 June). Foundry suppliers present the latest trends and techniques here.

Two special shows, organized by the House of the Foundry Industry (Düsseldorf), provide clarification on two of the latest themes to crop up. One of these is the subject of digitalization and its impact on the foundry industry, and the other is innovative solutions for preventing CO<sub>2</sub> emissions. Here, the as yet untapped potential in waste heat utilization, in particular, offers foundries significant opportunities to reduce energy costs and CO<sub>2</sub> emissions.

At the first established European CAEF Forum, visitors can see presentations on successful flagship projects and country-specific challenges in the countries which are members of the CAEF on Friday 28 June.

### The foundry industry: Caught between tradition and modernity

The VDG celebrates its 150th anniversary in 2019. In line with this, the BDG Forum on Saturday, 29 June is completely devoted to the foundry industry's development over the last 150 years. We will also look into the future to provide a contrast with this in the big Next Generation area (Hall 13, Stand C 38), which runs throughout the entire trade fair and focuses on the following aspects:



The organizers expect more than 2,000 exhibitors and about 78,000 visitors (Picture: Messe Düsseldorf)

- What can school pupils, apprentices and students expect to find in the foundries of the future? To answer this question, various projects will be presented in the exhibition space, for example:
- How much casting is integrated into a car? We take a car apart to find out.
- What have the various universities and foundry institutes got to offer in the affiliated Institute Show?
- Where can you find training locations for foundry mechanics?

More information on the entire programme can be found online at [www.bdguss.de](http://www.bdguss.de) from February 2019.

### Premiere: conference and special show on additive manufacturing

The special show in Hall 13 and the trade conference on additive manufacturing premiere at the GIFA. Whether you work in pattern and die making, in core making or in direct metal printing, foundries and their suppliers can open up tons of unforeseen potential using additive manufacturing. Both of the events acknowledge this proven fact. The "3D metal printing" trade conference focuses on the following hot topics on 26 June by giving technical lectures on them:

- how foundries are profiting from 3D printing,
- innovations in 3D metal printing,
- digital process chain,
- quality assurance,
- looking deeper and further into the possibilities.

Sebastian Bremen, the director of the Aachen Center for 3D Printing and group manager for Laser Powder Bed Fusion at the Fraunhofer Institute for Laser Technology (ILT), will be the chairman of the conference and moderator. The event is organized by Süddeutscher Verlag Veranstaltungen, and up-to-date information is available at: [www.sv-veranstaltungen.de/de/event/3d-druck-metall](http://www.sv-veranstaltungen.de/de/event/3d-druck-metall).

### The Bright World of Metals

The GIFA (International Foundry Trade Fair), METEC (International Metallurgical Trade Fair), THERMPROCESS (International Trade Fair and Symposium for Thermo Process Technology) and NEWCAST (International Trade Fair for Castings) are a set of four international technology trade fairs and will be held across 14 halls from 25 to 29 June 2019. It is expected that they will receive over 2,000 exhibitors and around 78,000 visitors. Casting products, foundry technology, metallurgy and thermal processing techniques will be shown to the world over the course of five days in the capital of the Rhine region. The trade fairs are accompanied by a high-quality programme including seminars, international congresses and series of lectures. For further information, please visit [www.gifa.de](http://www.gifa.de), [www.metec.de](http://www.metec.de), [www.thermprocess.de](http://www.thermprocess.de) and [www.newcast.de](http://www.newcast.de) or [www.tbwom.com](http://www.tbwom.com).

■ *Messe Düsseldorf – GIFA, METEC, THERMPROCESS, NEWCAST 2019*

## „Clean Energy“ initiative

# Cooperation partners Salzgitter Flachstahl, Avacon and Linde sign agreement for ground breaking energy project

Salzgitter Flachstahl GmbH, Linde AG and Avacon Natur GmbH signed a cooperation agreement today on the joint “Salzgitter Clean Hydrogen” innovation project, which signifies a big step toward a hydrogen-based industry.



Signed the cooperation agreement for the “Clean Energy” project (from left): Dr. Stephan Tenge, chief technology officer of Avacon AG; Ulrich Grethe, member of management board Salzgitter AG; Jens Waldeck, head of the Central Europe Region, Linde AG (Picture: Salzgitter AG)

German flat steel producer Salzgitter Flachstahl GmbH together with Linde AG and Avacon Natur GmbH signed a cooperation agreement on the joint “Salzgitter Clean Hydrogen” innovation project, which signifies a big step toward a hydrogen-based industry.

The aim of the project is to generate hydrogen in Salzgitter through electrolysis and electricity from wind power. These activities are to lay the foundation for the future deployment of larger hydrogen volumes to reduce direct CO<sub>2</sub> emissions in the production of steel.

Salzgitter Flachstahl is to plan the construction and operation of PEM electrolysis plant (PEM = proton-exchange membrane) with a capacity of around 400 N.m<sup>3</sup>/h. Avacon intends to build and operate seven wind turbines on the premises of the Salzgitter group, three of which on the grounds of the steel mill. Industrial gas supplier Linde will ensure the steady supply of hydrogen. The cost of the entire project (installation of the wind turbines and the hydrogen plant, including linking them up to the existing distribution networks) amount to around 50 million euros. The financing of this forward-looking industrial climate protection project also necessitates the acquisition of governmental funding. Assuming the project runs smoothly, the production of hydrogen on the plant premises could commence in 2020.

## Building know-how for the environmentally compatible production of hydrogen

In the context of this project, the partners are aiming to build up know-how for the environmentally compatible production of

**„In the future, hydrogen will play a key role in mobility, the production and storage of energy, as well as in many other industrial processes.“**

*Prof. Dr.-Ing. Heinz Jörg Fuhrmann, chairman of the executive board of Salzgitter AG*

hydrogen, as well as gaining experience with the on-site production of hydrogen and its incorporation into an integrated steel mill with its complex production processes.

Hydrogen delivered by Linde is already used today in the annealing processes that are part of producing steel. In addition, the use of hydrogen in mills opens up the potential of significantly reducing CO<sub>2</sub> emissions generated from steel production processes in the future. With a view to achieving this goal, Salzgitter AG conceived the SALCOS (Salzgitter low CO<sub>2</sub> steelmaking) project that maps a realistic path toward the gradual reduction of CO<sub>2</sub> and, in the long term, steel production that is virtually free of CO<sub>2</sub>. As part of this project, hydrogen generated from renewable energies is to replace

the carbon so far required for the smelting of iron ore.

Salzgitter Flachstahl intends to gain operational experience through this project in the area so important for SALCOS of generating “hydrogen from renewable energies”. This experience could later be used for implementation on an industrial scale. Although the framework conditions prevailing today do not permit the commercial operation of a direct combination of wind energy generation and electrolysis operations without government funding, the three partners are determined to take this technology that is so significant for the future and for climate protection further.

■ Salzgitter AG, Avacon AG, Linde AG

## Avacon AG

Avacon AG is Germany's largest distribution grid operator. The company reliably operates electricity and gas networks in the federal states of Saxony-Anhalt, Lower Saxony, Hesse and North Rhine-Westphalia. Avacon Natur GmbH is a wholly-owned subsidiary of Avacon AG. The company develops energy supply solutions based on renewable energies as well as innovative and efficient technologies for industrial enterprises, commercial and domestic customers. Avacon Natur GmbH is the company of Avacon AG entrusted with executing operations under the “Clean Energy” project.



# MAXIMUM PERFORMANCE

for better solutions.



COSWIG means first class roll cast and mould cast products as well as innovative engineering. Since more than 120 years we develop, engineer and produce sophisticated cast parts for various industrial sectors and requirements.

[www.walze-coswig.com](http://www.walze-coswig.com)



Please visit us  
at: Hall 3 / E20

A member of  
**DIHAG**  
HOLDING

Paul Wurth becomes new lead investor and technology partner of Sunfire

# Green hydrogen for large-scale commercial projects

Sunfire GmbH, developer and manufacturer of high-efficiency electrolyzers and fuel cells, secured 25 million euros venture capital in a series C financing round. New lead investor is the Luxembourg-based technology provider Paul Wurth S.A., a company of SMS group.

Thanks to the injection of fresh capital and with the support of Paul Wurth, Sunfire will implement as from 2019 commercial multi-megawatt projects applying high-temperature electrolysis and power-to-liquid technology. For Paul Wurth, this partnership means a significant step in view of new technological developments leading to green steelmaking as well as an opportunity to enter the growing e-fuels market.

The technologies developed by Sunfire allow producing climate-neutral fuels and gases for sectors which today can hardly do without fossil energy sources, such as heavy load transportation, aviation, steel industry or chemical industry. Green hydrogen is produced based on green electricity in an efficient high-temperature electrolyser, using waste heat generated for example by industrial processes.

## CO<sub>2</sub>-neutral oil substitute

In the latest product version, high-temperature electrolysis can not only reactivate water, but also CO<sub>2</sub> and thus transform, in the most direct way, combustion off-gases into clean feedstock, replacing fossil oil or natural gas. The produced hydrogen can be used directly or can be transformed in further process steps into the CO<sub>2</sub>-neutral oil substitute e-Crude. In refineries, it can be further processed into e-gasoline, e-diesel and especially e-kerosene for aviation. Presently, Sunfire is building the first high-temperature electrolyser at megawatt scale.

"Thanks to our so far largest financing round we pave the way for the industrialization of our technology validated in pilot plants. We experience daily how the interest for our solutions for energy transition is growing," says Carl Berninghausen,

**"Our collaboration with Sunfire clearly expresses our strategy to play a leading role in the upcoming transformation of the steel industry towards CO<sub>2</sub>-free steel production."**

*Georges Rassel, CEO of Paul Wurth*

CEO of Sunfire. For example, Salzgitter Flachstahl GmbH is counting on green hydrogen in a successful pilot project. "Therewith we have already set a signal in the steel sector. With Paul Wurth joining the venture, we become a valuable partner for energy intensive industries. This milestone means for us an important step towards an industrial company, and we will now be able to expand our pure product business to service activities also in the field of projects."

For Georges Rassel, CEO of Paul Wurth, "our collaboration with Sunfire clearly expresses our strategy to play a leading role in the upcoming transformation of the steel industry towards CO<sub>2</sub>-free steel pro-

duction. Paul Wurth designs and supplies complete blast furnace plants, coke oven plants as well as by-product treatment facilities for the primary stage of integrated steelmaking. We would like to accompany our customers also in their journey to hydrogen-based hot metal production and support them to achieve climate protection targets."

The existing Sunfire investors, INVEN Capital, Idivest Partners, Total Energy Ventures and „Sunfire Entrepreneurs Club“ participated in the new financing round.

■ Paul Wurth S.A., Sunfire GmbH

## High-temperature electrolysis

Founded in 2010, Sunfire GmbH develops and produces high-temperature electrolyzers (SOEC) and high-temperature fuel cells (SOFC). High-temperature electrolysis produces valuable hydrogen from water. It is particularly efficient and is powered by renewable electricity. In the latest version, high-temperature electrolysis can not only reactivate water, but also CO<sub>2</sub> and thus transform, in the most direct way, combustion off-gases into clean feedstock, replacing mineral oil or natural gas. Thanks to this technology, the entire transport sector and many industrial processes, relying today on oil, gas or coal, can be transformed in a sustainable and CO<sub>2</sub>-neutral way.



Indian refractory group is prospering

# GSB Group to become a member of Dalmia Bharat Group

GSB Group has joined hands with the Indian refractory giant Dalmia OCL. Dalmia OCL belongs to the 1.7 billion USD turnover enterprise of Dalmia Bharat Group.

As a result of the merger, GSB Group customers will now have access to a much broader range of refractory products such as silica bricks and various basic and non-basic bricks and continuous casting products. For the GSB Group, this merger offers great potential, especially with a view to accelerating the growth of the company, facilitated by the broader product portfolio.

“GSB Group is one of the global niche players in the refractory industry with its expertise in monolithic lances and RH snorkels; the GSB brand has a distinguished reputation; particularly, in the mind of European and Indian steel makers created through decades of successful operations in Bochum,

Germany and Bhilai, India. This strategic acquisition of GSB Group through Dalmia Bharat Group is placing us more prominent in the global market”, states



Checker bricks

Isostatic products (Figure: GSB Group)

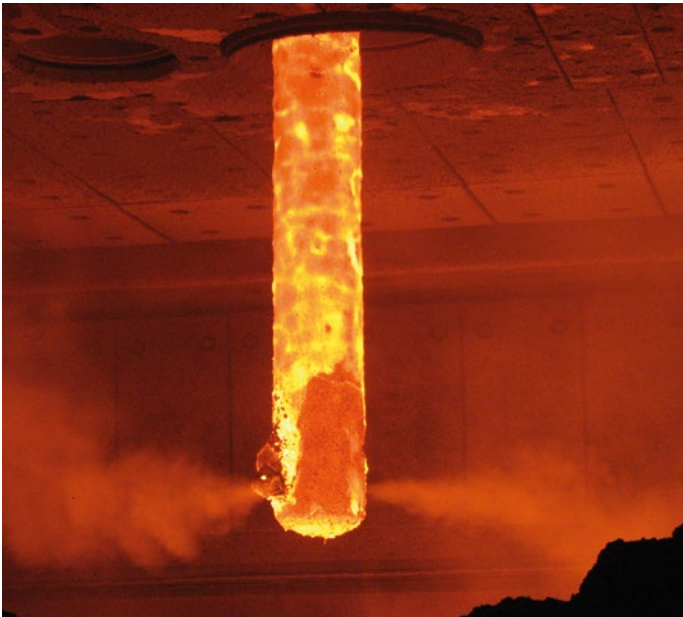

Lance (Figure: GSB Group)



Snorkels (Figure: GSB Group)

Mr Sameer Nagpal, the CEO of Dalmia OCL Refractories.

GSB Group was the first and continues to be the foremost monolithic refractory lance producer in Continental Europe. With its current production sites in Bochum (Germany) and Bhilai (India), GSB Group has become a well-established enterprise in the field of innovative special refractory products of the highest quality in the global iron and steel industry.

GSB Group is in the position to offer a comprehensive range of premium quality products – precast shapes, complete RH-degasser snorkels, CAS-OB bells, slag skimmers, monolithic ladle lip rings, purging

plugs, seating blocks, exchangeable nozzles for slide gate plates, refractory wall panels, various tundish furnitures, as well as wear resistant flexible elbows and other products. This means complete one-stop solutions for all kinds of monolithic lances and all other aforementioned products. Continuous product development and design activities are part of the enterprise's day to day business.

Traditionally, GSB Group has been known for its flexibility, consistent quality, innovation, best technical support and service to its customers. As part of Dalmia OCL, GSB Group will continue with its focus on delivering tailor made solutions and services

to its customers, now equipped with the additional tools to offer the complete range of refractory solutions for every application concerned.

Dalmia Bharat Group's refractory business comprises Dalmia Refractories (for the cement sector) and OCL Refractories (for the ferrous and non-ferrous sector). Dalmia OCL has four manufacturing sites in India and one in China. The core product lines of bricks include alumina, silica and basic.

www.gsb-group.com

### Technology of high-bay coil storage to be transferred to port logistics

## Joint venture between DP World and SMS group to build new container storage system

A new and intelligent storing system for containers will be applied for the first time ever at the Jebel Ali ship terminal 4, in time for the Dubai Expo 2020 world fair.

High-bay storage systems were originally developed by SMS group subsidiary AMOVA for round the clock handling of metal coils that weigh as much as 50 t each in racks as high as 50 m. AMOVA is the first company

to transfer this proven technology to the port industry.

Instead of stacking containers directly on top of each other, which has been global standard practice for decades, the system places each container in an individual rack

compartment. Containers are stored in an eleven-story rack, creating 200% more capacity than a conventional container terminal, or creating the same capacity in less than a third of the space. Thanks to the rack's design, each container can be accessed without having to move another one, enabling 100% utilization in a terminal yard.

The system brings big gains in speed, energy efficiency, better safety and a major reduction in costs. Expenses are further cut by the ability to shorten loading and unloading times.

Dr. Mathias Dobner, CEO of the joint venture, says: "This new container handling technology allows cities to use their expensive and sensitive land and waterfront areas more effectively. Our system will significantly increase the productivity of handling ships on the quay. This means that quay walls can be shortened by a third."



High-bay storing system for containers (Photo: SMS group)

SMS group

The new technical journal

# WE ACCOMPANY THE **FUTURE** OF THE INTERNATIONAL **STEEL INDUSTRY**

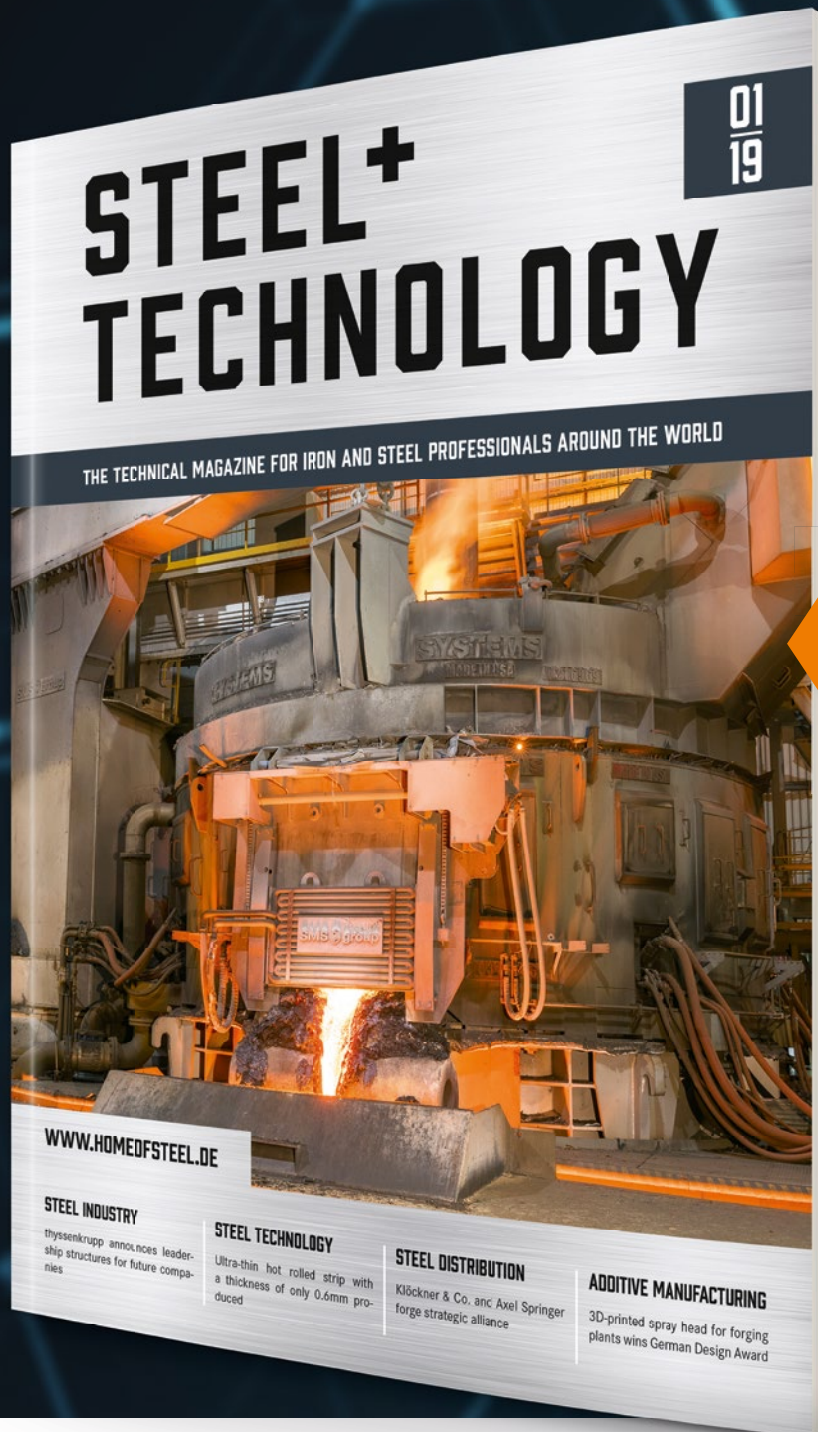

steel production  
application technology  
innovation + management  
processing

FREE SAMPLE PRINT ISSUES AND FURTHER INFORMATION AT  
[WWW.HOMEOFSTEEL.DE](http://WWW.HOMEOFSTEEL.DE)

**DVS** MEDIA

German Design Council honours a unique machine component

# Additively manufactured 3D spray head wins German Design Award

SMS group has been honoured with the award in the category "Industry" for its 3D spray head for forging plants.

A small machine component winning a design award is probably a first in the history of the German Design Award and certainly worth noting. The component for which plant and mechanical engineering company SMS group has received the German Design Award 2019 in the category "Industry" is a spray head used to cool dies in forging presses.

All involved in the various teams that have been working towards the common goal of adopting an entirely new approach to designing and producing a machine component were excited about the news. Not only the component as such was relevant for the judges, but also the fact that it exemplifies the various aspects of additive manufacturing, a technology that has been opening a whole range of new possibilities for the design and functional layout of components. Every year the German Design Council organizes the German Design Award, one of the most recognized design awards worldwide. This award recognizes innovative products and projects, and the companies or individuals who have fabricated and designed them.

## New way of thinking brings about components optimized for specific functions

Axel Roßbach, head of the project team, Technology Forging Presses + Extrusion Presses, SMS group GmbH: "Winning the Design Award makes us extremely proud. It is recognition of many teams within SMS group whose work is characterized by a highly interdisciplinary approach. The spray head is a milestone innovation marking a new era in the design of plant and machine components, enabled by the game-changing potential of 3D printing and function-optimized design. The design of a machine part is today no longer

limited by the constraints imposed by conventional – process-optimized – forming and machining techniques. Supported by latest software and computer technology, we can now give a component exactly the design that fulfils its designated function in the best possible way. Another important aspect is that we have used new materials. Therefore the award honours not only a new design, but above all the new way of thinking lived within SMS group, which has materialized in a global approach to additive manufacturing." According to Axel Roßbach, the new spray head is an example of how nowadays, in the digital age, different disciplines interact and what opportunities additive manufacturing holds in store. The new spray head solution produced by 3D printing is the result of a joint effort by the Forging Plants department, the Additive Manufacturing project team and the simulation technology experts of SMS group. Erdem Karakas, production engineer in the product design department: "We are in no way restricted by any manufacturing constraints. Therefore we can adopt a creative technological approach to designing and start out from the function the component is going to perform."

The jury states, the 3D spray head is characterized by „a unique, unmistakable technical aesthetic“ (Picture: SMS group)

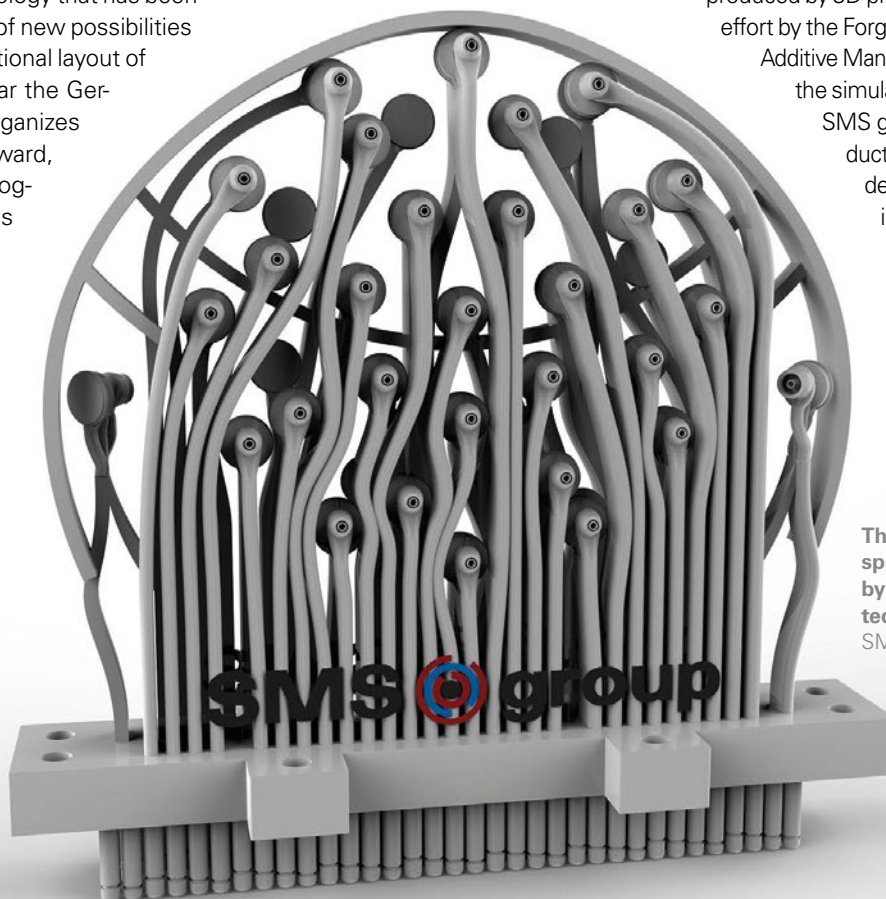

GERMAN  
DESIGN  
AWARD  
2019

## Only one tenth of the weight of the conventional component

Common spray heads are heavy and complicated to produce. Their heavy weight impairs the productivity of the forging press. Against this, the new spray head has been designed with a view to how it can fulfil its function in the most efficient way. It is significantly smaller, features flow optimized channels and cools the dies specifically and as required in each individual case. Die areas subjected to intensive heating are cooled at a correspondingly – precisely calculated – higher rate than areas less hot. Additionally, these spray heads can be produced virtually just in time. Axel Roßbach: “Although the spray head is only a small component, it nevertheless ideally represents the potential of additive manufacturing. The innovative manufacturing methods enabled by 3D printing form the basis for Industry 4.0. The example of the 3D-printed spray head makes this clear and measurable. Made of plastics, it weighs only one tenth of what a conventional one would weigh. A 3D spray head made of metal weighs up to 70 percent less. It is less expensive, more efficient and can be easily customized and instantly produced.”

## Lower costs, higher productivity

All this provides numerous advantages for drop forging operations. Drop forging presses are being constantly optimized with a view to achieving shortest cycle times and maximized service life of the dies. Spray heads for cooling and lubricating the dies

**“The special nozzle arrangement delivers outstanding spray performance while giving the novel 3D spray head a unique, unmistakable technical aesthetic.”**

*Statement of the jury*

perform a key function in the forging process as without them the dies would not be able to withstand the constant and extremely high stress acting on them during operation. The spray heads are introduced between the open dies awaiting the next forging stroke. The innovative SMS group solution means not only a reduction in weight and costs, but also reduced wear of the supporting arms which introduce the spray heads between the dies. Due to the significantly lower mass to be accelerated, cycle times of the – usually automated – processes can be shortened. Another key advantage for the press operator is the possibility of producing customized spray heads “on demand”; i.e. the spare heads are available in virtually no time, without incurring the high costs of keeping them physically in stock.

Also the environment benefits as the production of the spray heads consumes no more material than absolutely necessary. SMS group plans to also print current-conducting elements and sensors into the spray heads. This will make it possible to actuate the valves electrically and generate condition messages of the systems. The thus gained added value and the potential for process optimization make the 3D-printed spraying system for drop forging operations a technology ready for Industrie 4.0. “There is a new mindset required for complex AM

parts. It is important that colleagues adapt this new mindset, because additive manufacturing will become a crucial factor for our products”, says Sarah Hornickel, R&D project team at SMS group.

## Filigree shape proves successful under harsh operating conditions

One of the first customers using the new spray head in practice is Bharat Forge in Ennepetal, Germany. For Bharat Forge, the spray head was specifically designed to allow switching between water and a graphite-based spraying fluid. Both the forge operator and SMS group are extremely satisfied with the performance of the spray head. Bharat Forge: “The spraying pattern is much more homogeneous now. The dies are cleaner. Consequently the overall consumption of spraying fluid has decreased. Also handling is easier than with the conventionally manufactured spray heads. Accumulations of material, as frequently occurring inside the former spray heads, have not been found thanks to the flow-optimized design of the fluid channels.”

## Only one facet of the overall concept of additive manufacturing

Although the Design Award-winning spray head is in the focus of attention above all due to its extraordinary design, this is only one facet of the many activities underway at SMS group in the area of additive manufacturing. As the “Leading Partner in the World of Metals”, the company’s plans and strategies are of much wider scope. The company is not going to limit its AM activities to the design and production of innovative machine components, but will also offer integrated solutions for the complete process chain of additive manufacturing on the market.

## German Design Award

The German Design Award directly contributes to the overall commercial success. Prizes are awarded to projects that truly represent pioneering contributions to the German and international design landscape. The highly esteemed, international jury guarantees this. The German Design Award identifies and presents unique design trends: a competition that advances the design-oriented scene.

| German Design Council



The QR code links to a video showing the German Design Award 2019 meeting of the jury  
[https://youtu.be/mdd\\_pu87g6o](https://youtu.be/mdd_pu87g6o)

| [axel.rossbach@sms-group.com](mailto:axel.rossbach@sms-group.com)  
 Axel Roßbach, head of the project team Technology Forging Presses + Extrusion Presses, Forging Plants, SMS group, Düsseldorf

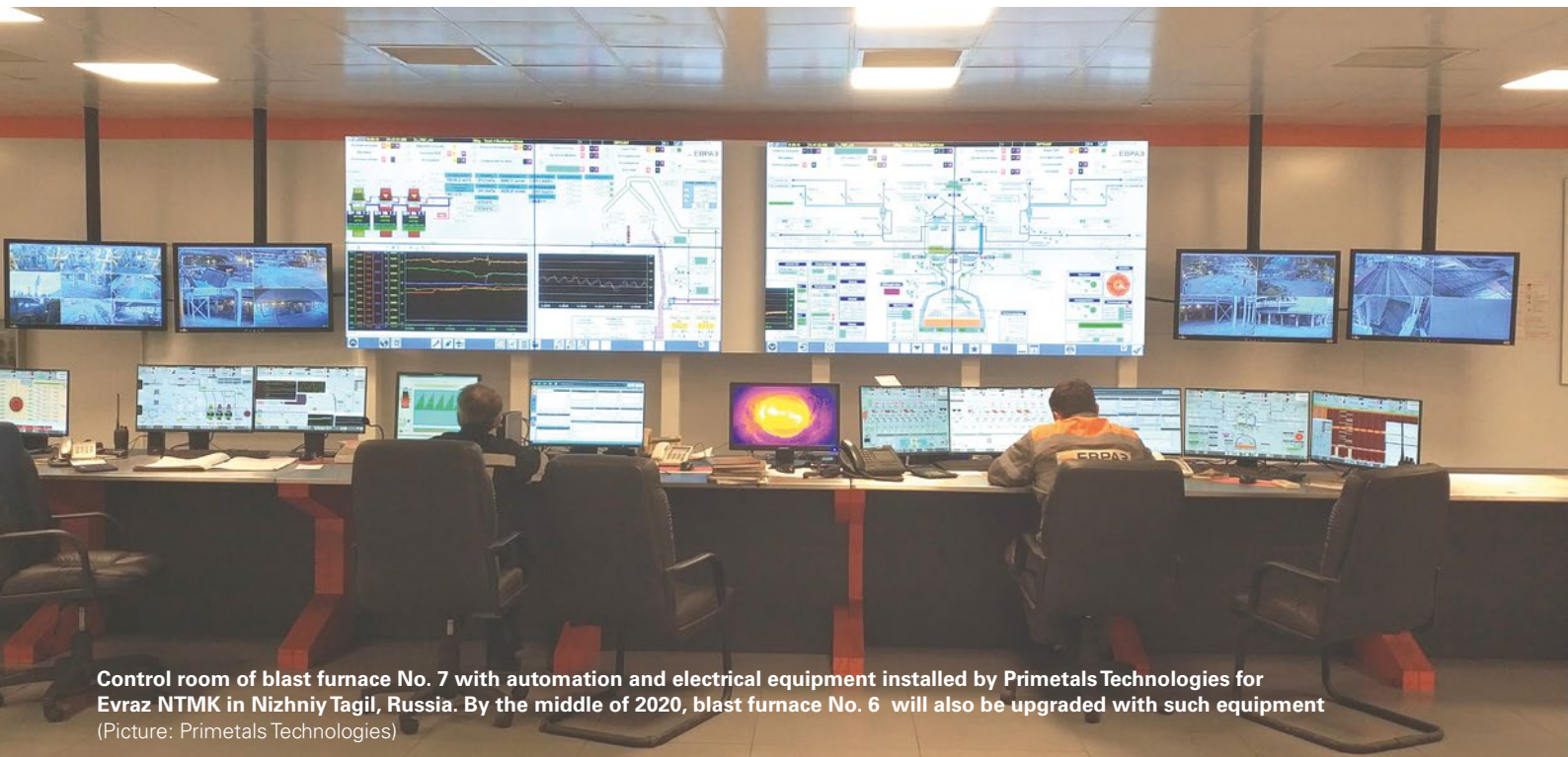

Control room of blast furnace No. 7 with automation and electrical equipment installed by Primetals Technologies for Evraz NTMK in Nizhniy Tagil, Russia. By the middle of 2020, blast furnace No. 6 will also be upgraded with such equipment (Picture: Primetals Technologies)

### Russian steel producer upgrades another blast furnace in Nizhniy Tagil

## Evraz NTMK relies on proven solutions for the reconstruction of blast furnace No. 6

As last year, when blast furnace No. 7 was rebuilt, Primetals Technologies will again supply automation and electrical equipment. Process automation optimizes operational parameters and reduces coke consumption. The fully virtualized automation system helps to reduce servicing costs.

Primetals Technologies has received an order from Evraz NTMK to supply automation and electrical equipment for the reconstruction of the blast furnace No. 6 at the Nizhniy Tagil Metallurgical Plant (Evraz NTMK). The basic automation (level 1) and the process optimization (level 2) will be installed as a virtualized automation system on central, redundant servers, which will drastically reduce servicing costs, especially those for future upgrades. The new process automation will enable the operational parameters of the furnace to be optimized and coke consumption to be reduced. The order is worth several million euros. The blast furnace is scheduled to be commissioned by the middle of 2020. Primetals Technologies previously supplied

the electrical equipment and automation for the blast furnace No. 7, which has been in operation since the beginning of March 2018.

After running for 15 years, blast furnace No. 6 was shut down at the start of 2018. The blast furnace will be completely demolished, including the secondary plant equipment, such as the stockhouse, hot-blast stove, gas cleaning and dedusting systems. It will be completely rebuilt, and as from 2020 is scheduled to supply the hot metal for the plant in Nizhniy Tagil together with blast furnace No. 7, which was brought into operation in 2018.

With an annual production of 4.9 million t of hot metal and 4.2 million t of steel, Evraz NTMK is one of the largest steel works in Russia. The integrated iron and

steel works is located in the city of Nizhniy Tagil in the Sverdlovsk region of the Urals. It primarily produces train wheels, rails, structural steel, pipe blanks and semifinished products. Nizhniy Tagil is one of the oldest Russian steelmaking and mining centres.

A major reason for winning the order was the company's good experience with the automation and electrical equipment Primetals Technologies had installed in blast furnace No. 7. In the past two years, Primetals Technologies has also received orders to install automation equipment in five blast furnaces in Brazil, Europe and India.

**| Primetals Technologies**

## Immediate action required

# Blast furnace at Tata Steel Kalinganagar back in operation after hearth chill

A team of experts from Danieli Corus and Tata Steel IJmuiden reestablishes discontinued hot metal supply for steel production in Kalinganagar.

**A**s a consequence of problems in auxiliary plant areas as well as disrupted hot-metal logistics caused by a torpedo car derailment, process irregularities escalated at Tata Steel Kalinganagar blast furnace No.1 and put the hearth into a "chilled" condition, immediately stopping production. The Kalinganagar works relies on a single blast furnace for the full supply of hot metal to downstream operations, and immediate action was required.

A team consisting of Danieli Corus experts and senior operational staff from the Tata Steel site in IJmuiden, Netherlands, travelled to India to implement advanced recovery practices based on applying oxy-fuel lance technology in combination with highly-specialized operational expertise.

After 16 hours of drilling, lances could be inserted and ignited in order to restore the connection between the tapholes and tuyere level that is required for restarting production. After 95 hours, sufficient heat had been introduced into the furnace

hearth to allow for reconnection to the hot blast system, marking the restart of the reduction process. On the fourth day, the first cast was made and nine days into the recovery project 60% of the tuyeres had been reopened. Within two weeks after the first cast, hot metal quality was with-

in specification for processing at the BOF plant. This brings the number of successful blast furnace recoveries handled by Danieli Corus to 37.

**| Danieli Corus**



**The joint Danieli Corus and Tata Steel team after the successful restart of the blast furnace**  
(Photo: Danieli Corus)

## Evraz NTMK blast furnace No. 6 to be ready by late 2020

**By October 2020, Evraz will complete a technical upgrade of blast furnace No. 6 of their integrated iron and steel works NTMK located at Nizhniy Tagil in the Urals, Russia.**

The modernization will concern all systems of the existing installation and enables increasing the nominal capacity by about 40% compared to the previous campaign design. With a hearth diameter of 9.8 metres and an inner volume of 2,200 cubic metres, the new furnace will

be able to produce 2.5 million tons of hot metal per year.

Paul Wurth will supply the following systems to equip the furnace: a parallel-hopper type Bell Less Top (BLT®) charging system, a complete top gas cleaning plant, copper staves for the high heat-loaded areas of bosh, belly and lower stack, the complete hearth refractory lining with ceramic cup as well as, on behalf of TMT, fully hydraulic clay guns, tap hole drill and main runner cover manipulators, all for two tapholes, as well

as tilting runner drive units. The technical solutions and the equipment basically repeat the technology installed at NTMK's new blast furnace No. 7 which went into operation in February 2018. The charging system and the tapping machinery are going to replace competing systems, thus contributing to consolidating the leading market position of these Paul Wurth and TMT technologies.

**| Paul Wurth**

**Outokumpu to invest at the Tornio production site, Finland**

## Nordic stainless steel producer starts up modernized AOD converter

Primetals Technologies has installed a new tilting drive and a new trunnion ring. The new damping system eliminates more than 50 percent of the vibrations from the blowing process and hence reduces wear and maintenance costs.

In December 2018, the No. 1 AOD converter modernized by Primetals Technologies was started up at the Tornio works of Outokumpu Stainless Oy, a Finnish stainless-steel producer. The project involved fitting the converter with a new tilting drive, trunnion ring and other associated equipment, including the electrical installations and automation. The Vaicon Drive Damper system developed by Primetals Technologies was also installed on the tilting drive. It reduces the vibrations produced by the blowing processes and thus the mechanical loads acting on the entire system from the converter down to the foundations. The patented system reduces wear and maintenance costs while also lengthening the service life of the plant. It can be installed in new plants or retrofitted on existing converters.

Outokumpu is one of the world's leading producers of stainless steels. The company employs around 10,000 people in over 30 countries, and has its headquarters in Helsinki, Finland. The works in Tornio, Lapland, is an integrated production complex with a cold rolling capacity of 1.2 million metric tons per annum. The chromite ore used in the works comes from a mining operation in nearby Kemi, which is also run by Outokumpu.

Primetals Technologies was responsible for the planning, manufacturing and supply of the new converter equipment. This covered the trunnion ring, tilting drive, including the damping system, the rotary joint and the pipework. The scope of supply also included the level 1 software and hardware for the tilting drive and damping system. The major components are a safety PLC, remote I/Os, frequency converter, local control pulpits, engineering station and a process data recording system. The process images required for visualization are integrated into the existing control system.

Primetals Technologies also handled supervision of the installation, commissioning and start-up of the AOD converter.

### New damping system reduces wear

The AOD (argon-oxygen-decarburization) refining process is used to produce stainless and high-alloyed steels. Large quantities of oxygen, argon and nitrogen are injected laterally to mix the bath thoroughly and minimize the unwanted slagging of alloying elements. This process-related lateral injection during the refining process sets the bath and the several hundred metric tons of the AOD converter in vibration.

This causes dynamic stresses, which reduce the service life of the mechanical components of the plant, and increase the amount of maintenance required, especially on account of premature wear on the bearings and gearing of the tilting drive. The Vaicon Drive Damper developed and patented by Primetals Technologies reduces the induced vibrations and the associated mechanical stress on the converter mechanism by more than 50 percent.

The damping system consists of two hydraulic dampers developed jointly with Hainzl, an Austrian company, as well as measuring systems and evaluation and control software. The dampers are installed parallel to the torque support of the converter tilt drive and are driven independently of it. This design ensures high availability and also makes it easy to retrofit in existing plants. Each damper has a closed hydraulic circuit, which makes an additional, external hydraulic system unnecessary. The damping effect is achieved by means of an electrohydraulic proportional throttle valve and is therefore continuously adjustable. The thermal energy generated by the damping is dissipated by an integrated water cooling



**Modernized AOD converter at Outokumpu Stainless Oy in Tornio, Finland** (Picture: Primetals Technologies)

system. The dampers are equipped with a position measuring system as well as pressure and temperature sensors. All process data – such as vibration displacement, temperature, pressure and damping force – is recorded and evaluated by software developed by Primetals Technologies. This facilitates a fast, effective response to the momentary vibration state of the converter.

**Primetals Technologies**



With integrated dedusting and heat recovery system

# Acciaieria Arvedi commissions new electric arc furnace

Italian steel producer Acciaieria Arvedi has issued the final acceptance certificate for the electric arc furnace installed by Primetals Technologies in the Cremona steel works. Commissioning was completed in just 31 days, two weeks before the agreed deadline.

The new 150-ton electric arc furnace increases the production capacity of Acciaieria Arvedi and reduces conversion costs. Primetals Technologies' scope of supply also included a dedusting system for primary and auxiliary dedusting and for supplementary extraction points. This is combined with a heat recovery system, which uses the thermal energy in the furnace offgases to generate steam, which is then used in the works' three pickling plants.

The tap-to-tap time is just 36 min and is supported by single bucket operation. This enables around 200 t/h of crude steel to be produced. The electricity requirement of the furnace lies between 340 and 350 kWh/t. The necessary energy is provided via a transformer with a power of 155 MVA. The furnace is usually charged with a mixture of 65% scrap iron, 25% pig iron and 10% HBI (hot-briquetted iron).

The scope of delivery also included five refining combined burner (RCB) systems, burners for postcombustion, a newly developed electrode control system (Melt Expert), the FluidGuard system – a comprehensive water leakage control system – and a new type of automatic tap hole filling. This increases safety as no personnel need to be near the furnace. Primetals Technologies also supplied a level 2 process optimization system, well prepared for Industry 4.0.

## Improved environmental footprint

An existing dedusting system was modified for the new electric arc furnace. The total extraction volume has been increased by installing an additional filter for both auxiliary and supplementary extraction points on the new electric arc furnace. The dedusting system meets the strictest European environmental requirements.

To optimize the energy balance of the plant, the waste heat from the electric arc furnace is recovered and used to generate steam. Some 17 t/h of steam are generated from the energy recovered from the waste heat. This steam is used for the three pickling lines in the steel works. The energy recovery system replaces the existing gas boiler in the steel works, thereby reducing gas consumption and thus energy costs.

Acciaieria Arvedi S.p.A. is part of the Arvedi Group based in Cremona, Italy. The works has two production lines for flat products. In addition to the steel works

for the production of liquid steel, there are two casting-rolling lines in operation. One of these lines uses the innovative Arvedi ESP (endless strip production) process and was realized in collaboration with Primetals Technologies. Production is mainly concentrated on special steels, in particular high-strength steels and dual-phase steel (DP), as well as thin and ultra-thin sheet metal, which can replace cold-rolled products in many applications.

Primetals Technologies



New electric arc furnace at Acciaieria Arvedi in Cremona, Italy (Photo: Primetals Technologies)

## 100 million euros investment at Saarstahl

# Implementation of the new continuous casting plant is on track

While the whole work is coordinated with precision and executed with willingness to achieve the new billet caster will certainly start up operation by end of the year.

Saarstahl group with its headquarters in Völklingen, Germany, is specialized in the manufacture of wire rod, bar, semi-finished long products and heavy forgings in qualities to meet the highest demands. Since November 2017, construction work on the new continuous casting plant "S1" has been running at full speed. The project represents a total investment of 100 million euros and requires that all tasks be coordinated with the greatest precision to ensure that the system can go into operation according to schedule at the end of 2019. The new billet caster comprises a five-strand circular arc machine followed by a comprehensive soft reduction zone. In this zone, the strand in the semi-solid state is defined using upper and lower rolls thus improving the internal microstructure of the steel decisively.

In February, Martin Baues, chief technical officer at Saarstahl, gave representatives of the media a rare look behind the scenes at

the ongoing construction work: "This construction site is particularly challenging for us since the new continuous casting plant is a unique system in the world designed with mechanical soft reduction (MSR) for casting formats of 180 mm x 180 mm and which is also equipped with the latest automation and communication technology. We are glad and proud that we are precisely on schedule with the construction work."

The system will be erected in the location where the predecessor plant, the "old" S1 was decommissioned in 2010. After the dismantling work on the old system and work to build the functional building and in the area of the system pit, now assembly of the main components is being carried out, i. e. the continuous casting machine itself and the turnover cooling bed as well as assembly of auxiliary aggregates and the infrastructure. To date, around 125 partner companies have worked on the construction site. Of these, around 70% are based

in the Saarland region and in the surrounding area. At the same time, a maximum of around 200 people are working on the construction site at any one time and, in total, 800 people will have been involved in the completion of the project.

Martin Baues highlighted the concept and significance of the system saying, "We are equipping the new continuous casting plant S1 with the latest automation and communication technology and we already took the approach of Industry 4.0 into account in developing the concept. This will enable us to monitor the processes on the new system even better and to ensure a maximum in quality assurance. As a result, we will be able to manufacture steel solutions tailored to our customers individual requirements even more flexibly and faster in the future."

Saarstahl operates a total of four continuous billet casting machines. With the new five-strand caster Saarstahl is strengthening its position in the business fields of spring steel (e.g. chassis springs and coupling springs), cold-heading wire (e. g. for screws, threaded bolts) and free-cutting steel (e. g. for the manufacture of valves, injection elements); products which are primarily used in the automotive industry and in mechanical engineering. The technical data for the continuous casting plant S1 are as following

- billet format: 180 mm x 180 mm,
- billet length: 6 m to 13.5 m,
- production capacity: approx. 180 t per hour,
- billet output: approx. 60 billets per hour,
- casting radius: approx. 10 m,
- length of cooling bed: 100 m.

Saarstahl is investing approx. 10 million euros in environmental protection, e.g. measures for noise reduction in the design of the system, closed water cooling circulation, reduction in the consumption of fresh water, water purification, etc.



In a few months the casting machine will be installed here at the construction site (Picture: Saarstahl)

■ Saarstahl AG

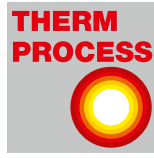

# INCREASE AWARENESS OF YOUR FAIR PRESENTATION WITH THE ONE AND ONLY OFFICIAL TRADE FAIR NEWSPAPER

- ✓ over 50,000 copies
- ✓ hot off the press with in-depth coverage on all 5 days of the fair
- ✓ available:  
at all fair entrances  
for all fair visitors  
on all booths  
at all symposia and lectures  
at Düsseldorf central station  
at Düsseldorf airport  
before the start of the fair in hotels  
in the Düsseldorf area



Media kit and information at [www.homeofsteel.de/fair-news](http://www.homeofsteel.de/fair-news)

Katrin Kuchler | T +49 211 1591-146 | [katrin.kuechler@dvs-media.info](mailto:katrin.kuechler@dvs-media.info)



## New mould design for continuous casting machines

# Mould concept for enhanced productivity and high quality in billet and bloom production

Power Mould™ is the brand name of an innovative, patented cartridge-type mould developed by Danieli to increase casting speeds by up to 50% in comparison to a conventional mould.

The Power Mould's innovative design of drilled channels inside the copper tube helps to reduce off-corner cracks, thereby increasing the sub-surface quality. This design concept aims at the following productivity and efficiency targets:

- running for 23 h at an average casting speed of 6.2 m/min in endless mode,
- casting above 45 t/h per strand in a billet caster in open stream and 76 t/h per strand in submerged casting (designed for up to 115 t/h),
- a service life of the copper tube equivalent to up to 60,000 t,
- 30% less media consumption, compared to a conventional mould.

In order to reach the above figures, the design engineers at Danieli went through a learning curve of mould design. The first trial was with a new mould that consisted of four thick copper plates with drilled longitudinal holes. Subsequently, the contact joints between the copper plates along the corners were improved and revised by introducing a monolithic tube: the result was the free-standing

Power Mould, which does not require additional back plates or water jackets for alignment.

### Approaching the next level

The thickness of the copper tube and the longitudinal cooling drill holes enable different cooling strategies to be applied by changing the numbers of holes, the distances between them and the distance from the steel. This solution ensures the most appropriate temperature distribution around the product section, which is an essential condition for uniform shell growth along the mould.

Realizing the consistency of performance and operations achieved with the Power Mould, the mould designers focused their attention on modifying the construction with a view to further improving the competitiveness of the product costs. The result is the Eco Power Mould. In this latest upgrade of the technology the copper effectiveness has been enhanced by employing a lower

thickness tube and a new design of the water cooling channels. These measures lead to a lower meniscus temperature and lower media consumption by the mould. In summary, the Eco Power Mould offers a range of substantial benefits, including:

- very high casting speed of 7.2 m/min when casting sections 130 mm x 130 mm,
- strand productivity of approx. 56 t/h (designed for up to 115 t/h when casting bigger sections),
- reduced off-corner cracks, i.e. increased sub-surface quality,
- improved cooling system,
- adaptive heat transfer,
- optimized high rigidity,
- reduced media consumption.

The Eco Power Mould can be easily installed on existing continuous casters. The return on investment (ROI) is usually less than twelve months.

■ Danieli Off. Mecc. S.p.A.

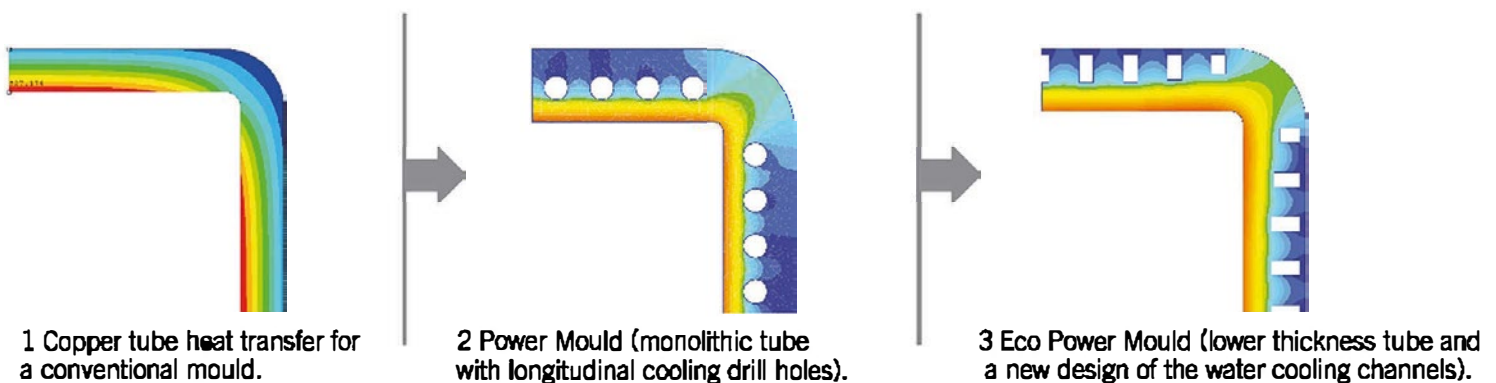

Comparison of the heat transfer in a conventional mould (left), the Power Mould (middle) and the new Eco Power Mould (right)  
(Picture: Danieli)

Hyundai Steel implements new spray cooling technology at the continuous slab caster

## Advanced pulsating spray cooling system for strand cooling

DynaJet Flex system reduces appearance of corner cracks when continuous casting of advanced steel grades. It provides highest discretization of cooling zones in width direction. Pulse-width modulated cooling widens the operation window with higher turn down ratio. In addition, operational costs decrease due to reduced scarfing losses and air consumption.

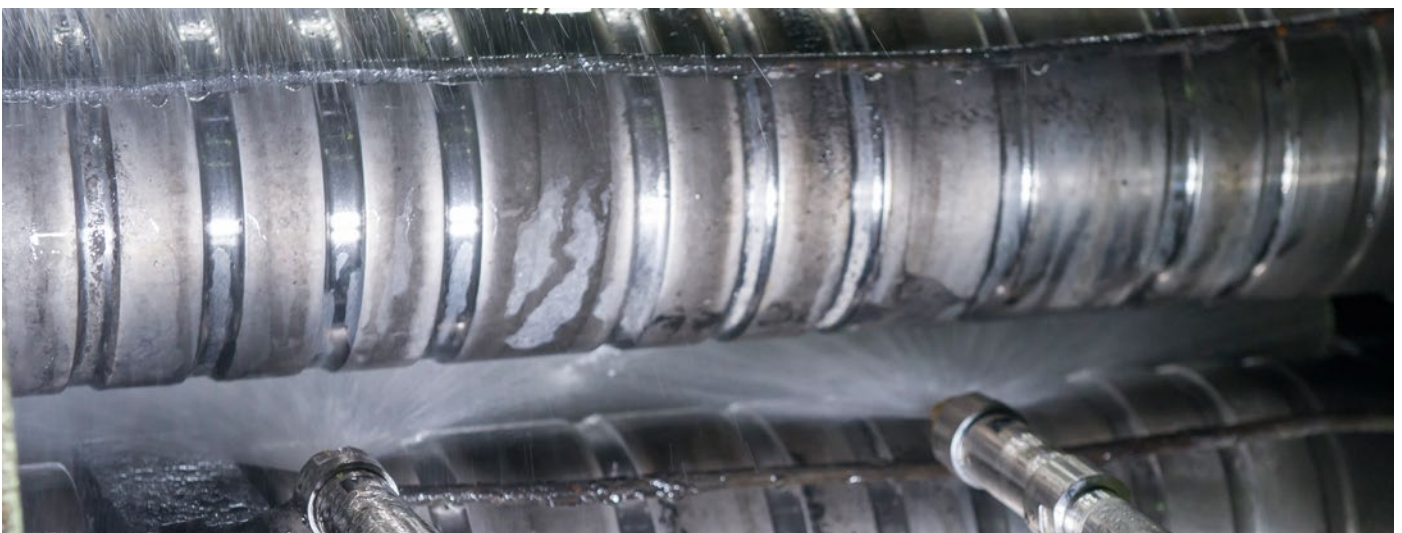

DynaJet Flex pulse-width cooling system mounted in bender zone (Picture: Primetals Technologies)

In November 2018, the newly introduced DynaJet Flex spray cooling system from Primetals Technologies has been started up at the two-strand continuous slab casting machine CC2 in the Dangjin, Korea plant of Hyundai Steel. DynaJet Flex allows for pulse width modulated cooling, thus enabling highest discretization of cooling zones in width direction and widening the operation window with higher turn down ratios compared to cooling systems currently in use. This minimizes the appearance of corner cracks especially for advanced high-strength steels (AHSS). Consequently, scarfing losses and in addition air consumption are reduced. This is the first industrial application of DynaJet Flex technology. The order for the new system for the first strand was placed in late November 2017. After a successful test, the application of the system on the second strand was ordered immediately.

Caster CCM2 has a rated capacity of 2.8 million metric tons of slab per year. It

has a machine radius of 9.5 metres and a metallurgical length of 43.5 metres. Slabs are cast in a width range of 800 to 1,650 millimetres and a thickness of 250 millimetres. Hyundai Steel is producing special steels for the automotive industry, e.g. Hyundai Motors, such as AHSS of the second and third generation. Such crack sensitive steel grades require a width-adjustable secondary cooling to avoid overcooling of the slab corners. In order to adjust spray cooling in the bender area for slab width ranges from 800 to 1,650 millimetres, a 4-step margin control with the DynaJet Flex system was installed on CCM2.

### Water-only nozzles are driven with a modulated signal

Today, secondary cooling of continuous casting machines is typically equipped with air-mist nozzles to achieve a wide turn down ratio which is the highest to lowest water flow without jeopardizing

the spray pattern uniformity. To prevent corner cracks the zones are additionally split into centre and margin strips across the casting direction. DynaJet Flex is the new cooling system to put the discretization of cooling zones at casting machines to the next level. By using water only nozzles, which are driven with a pulse width modulated signal, it is possible to increase the turn down ratio compared to air mist systems and significantly reduce the operating costs by reduced air consumption. The system can be installed on a segment during a planned maintenance cycle. After reinserting the segment into the machine DynaJet Flex is immediately activated. From then on the segment is ready to operate and provides the drastically refined cooling control for an optimal slab temperature, both longitudinally and transversely.

Primetals Technologies

## Automation in the hot strip mill

# Continuous optical strip position measurement

The EMG hotCAM system installed by EMG Automation at Baosteel Meishan, China, has been in operation for more than half a year now. Measuring the strip position on three stands of the hot strip mill has made rolling safer and more reliable and has reduced the amount of scrap.

For process reliability in a hot rolling mill, it is extremely important to maintain a defined position of the strip between the rolling stands. Continuous optical strip position measurement with EMG hotCAM allows the mill operator to optimize the setting of the rolling force and the rolling gap and at the same time provides the necessary basis for automatic or semi-automatic control.

In July 2018, the first strip position gauge of this type in Asia was commissioned at Baosteel Shanghai Meishan Iron & Steel Co., Ltd. The installation consists of three cameras on three rolling stands in which the thickness of the about 1,100°C hot strip is reduced from approx. 20 to 30 mm down to 1 to 6 mm.

## Measurement in the NIR spectrum

The CMOS camera technology of EMG hotCAM uses the radiation of the hot

material in the near infrared spectrum (NIR) to detect the strip edges via the strong contrast in comparison to the colder environment. By continuously tracking the strip centre position over several rolling stands, deviations from the target position of the strip can be detected at an early stage allowing the operator to take corrective action.

The camera assembly and adjustment unit is protected by a jacket, which not only provides additional protection for the camera housing, but also ensures that the camera can be readjusted via the adjustment unit even after a long period of operation. Contamination of the camera lens itself is reliably prevented by a sophisticated compressed air flushing system, so that the system works maintenance-free for months.

A special challenge are the ambient conditions. The use of water and rolling

emulsion generates steam and rolling mist, which makes the reliable detection of strip edges more difficult. EMG hotCAM uses CMOS area scan cameras which make real-time image processing much more stable than with line scan cameras, since strip edges do not have to be reconstructed in a complex procedure. This fact, together with the high-contrast NIR images, results in a reliable continuous determination of the strip edges and an accuracy of the strip centre position  $\pm 1.5$  mm. By accurately measuring the strip position over several rolling stands, the rolling mill can be safely operated and scrap significantly reduced. Also the occurrence of cobbles can be largely prevented.

EMG Automation



The installation at Baosteel Meishan consists of three cameras on three rolling stands (Photo: EMG Automation)

**New thermomechanical rolling capabilities to extend the range of added-value steels**

# Nucor to modernize the Gallatin thin slab casting and rolling plant

In order to extend the range of steel grades and increase production capacity, Nucor has contracted Danieli to upgrade its hot strip plant in Ghent, Kentucky (USA). The modernization project includes a new thin slab caster, stands and mill upgrade and a new meltshop, too.

Nucor has started a comprehensive upgrade project for its hot strip production facility Gallatin Steel. The new plant configuration will modify the technology completely – from a compact thin slab casting and rolling plant to a ultra-modern QSP® (Quality Strip Production). It will allow Nucor Steel Gallatin to improve thermomechanical rolling capabilities, therefore expanding production of AHSS grades, API line pipe steel grades and a number of other added-value grades. This is the first time that a classical compact thin slab casting and rolling plant is fully reconfigured into an ultra-modern QSP® facility.

The revamped plant will include a new meltshop comprised of a high-performance DC EAF featuring the Q-Melt package, twin ladle furnace and provision for a vacuum degasser in the future. Both Nucor and Danieli teams are committed to set a new benchmark in casting and rolling technology. "This investment is another major component of our strategy for long-term profitable growth," explained Ladd Hall, executive vice-president of flat-rolled products at Nucor. "This expansion increases our presence in the Midwest market, specifically in the automotive, agriculture, heavy equipment, and energy pipe and tube sectors."

## Gallatin Steel Co., now Nucor Steel Gallatin

Formerly known as the Gallatin Steel Company, the plant located in Ghent, Kentucky (USA) has an annual production capacity of 1.6 million short tons (1.45 million t) of hot rolled coils having a thickness range from 1.4 to 12.7 mm, widths up to 1,625 mm and maximum coil weight of 35 short tons (32 t).

The plant operates a 185-t twin shell DC EAF, a single ladle metallurgical furnace, a vertical thin-slab caster, 206-m tunnel furnace, a six-stand close-coupled rolling mill,

traditional laminar cooling and one down coiler. The current capabilities of the steel plant are mostly structural steel, micro-alloyed grades and thin line pipe grades.

Like similar compact plants, Gallatin was originally designed for doubling the annual capacity by means of a second steel meltshop and second vertical casting strand, with a tunnel furnace connected by a swivel ferry system to the in-line hot strip mill. The original expansion plan called for the new equipment to be a copy of the existing installation.

In October 2014, Nucor Steel became the owner of the Gallatin Steel Company, and has recently approved an investment to advance the technological capabilities and competitiveness of the Nucor Steel Gallatin sheet mill. Danieli was selected

as technology supplier for the complete equipment and automation system, from raw material to hot rolled coil.

"The Nucor and Danieli teams worked together for over a year to find the best solution for the upgrade of our Kentucky sheet mill. In the end, the Danieli QSP technology was the right fit for the project. It will allow Nucor Steel Gallatin to better serve our customers today and into the future," commented John Farris, vice president and general manager, Nucor Steel Gallatin.

## Re-engineering the production facility with QSP technology

In the spirit of full partnership, the Nucor and Danieli team of specialists agreed



Finishing stands of the QSP hot strip mill under operation at MMK Atakas, Turkey (Picture: Danieli)

**Layout of existing CSP plant NSGAL**

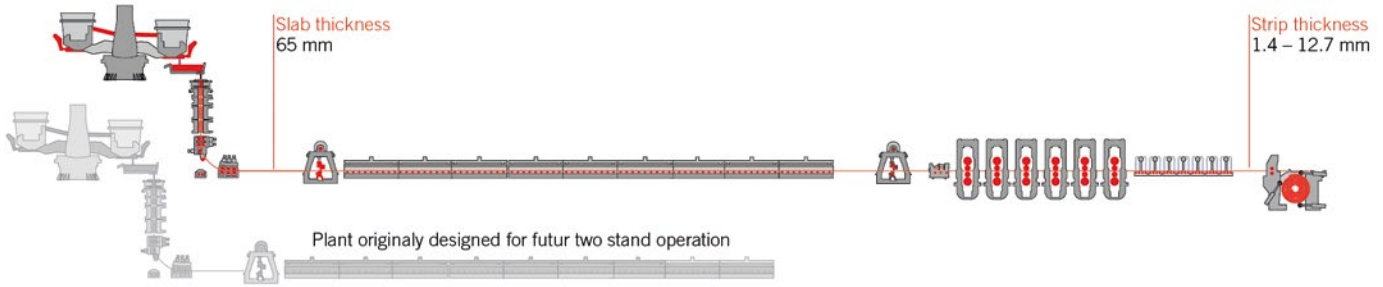

**Transformation of CSP plant to QSP® plant**

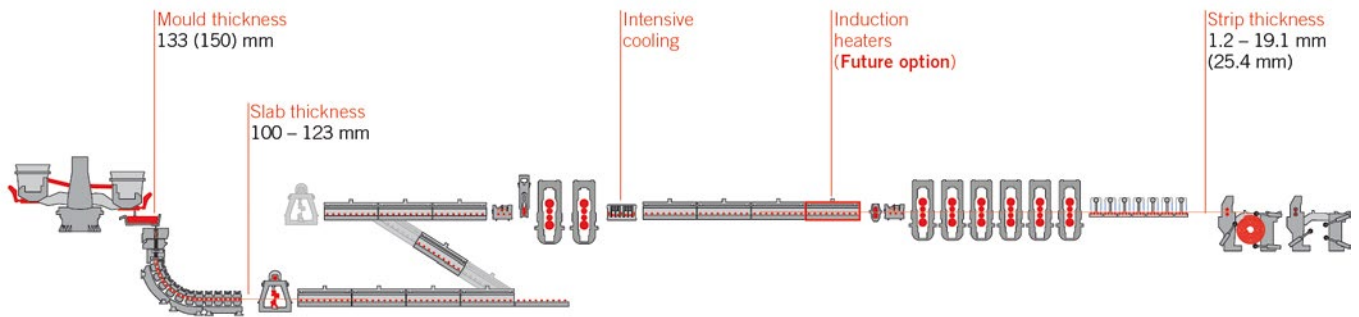

**Vertical curved TSC**  
For highest quality and productivity

**Tunnel furnace**  
With swivel ferry system

**2 + 6 HSM design**  
For an unlimited product-mix

**In line thermo-mechanical**  
For tailor made properties

Layout of the existing CSP plant and the future QSP plant at Nucor Steel Galatin (Picture: Danieli)

to re-engineer the plant by changing the original concept into an advanced QSP® plant having improved thermomechanical rolling capabilities, thereby expanding production of AHSS grades, API line pipe steel grades and a number of other added-value grades.

The revamped plant will include a high-performance DC EAF and twin ladle furnace, with provision for vacuum degassing in the future. The new meltshop will make use of the most recent process management tools. One of these will be the new Q-MELT technological package,

which is a key function for optimizing the transformation costs.

“Industry 4.0 is a key aspect in the process control, either by applying adaptive process control for the EAF, where Q-MELT dynamically will alter the EAF profiles for the best practice, or by using mechatronic technologies that make it possible to conduct the majority of the operations remotely from the main pulpits. Safety and productivity are the pillars that will guarantee the success of this project,” explained Paulo da Costa, meltshop technical sales manager at Danieli.

If for the meltshop the project foresees doubling steelmaking capacity by installing a new production unit, the design vision changes for the casting and rolling plant. After the upgrade, the complete production will be delivered by a single-strand vertical curved caster having a total capacity of up to 3.0 million short tons per year.

The new caster represents the fifth generation of Danieli high-production slab casting machines. The vertical-curved caster will be equipped with a complete suite of advanced technological packages, including

**“This investment is another major component of our strategy for long-term profitable growth. This expansion increases our presence in the Midwest market, specifically in the automotive, agriculture, heavy equipment, and energy pipe and tube sectors.”**

*Ladd Hall, Executive Vice President Flat-rolled Products at Nucor*



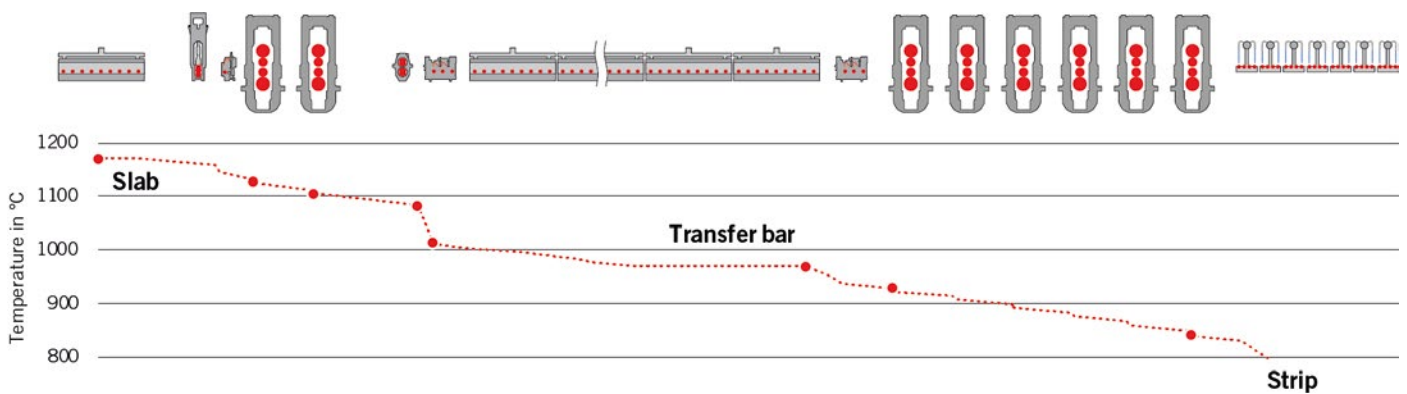

Product temperature curve during thermomechanical rolling (Picture: Danieli)

Danieli’s latest design of multi-mode electromagnetic brake (MM-EMB) to ensure the control of fluid dynamics within the mould, enabling high throughput of quality thin slabs.

The slab will be delivered to the rolling mill by a new tunnel furnace via a swivel-type ferry system. The new layout will allow for the installation of the new caster and first portion of the tunnel furnace and swivel system without affecting the mill’s production. Furthermore, two new roughing mills will be added to expand rolling capabilities. The tunnel furnace and the transfer bar furnace installed between the roughing stands and finishing stands will be supplied by Danieli Centro Combustion.

The independent high-speed roughing, intermediate transfer bar cooling and final finishing rolling introduces the ability to perform a thermomechanical rolling process, as is typical for conventional hot strip mills. This will lead to a complete replacement of the existing tunnel furnace, widening of the finishing mill equipment, new run-out table with advanced combined intensive and laminar cooling and two new down-coilers with coil handling.

### Higher-quality, wider strip to be produced

The six-stands finishing mill will be retained but it will be widened and upgraded with new interstand guides, loopers and a new bending and shifting system. This will allow Nucor Steel Gallatin to roll strips as wide as 1,870 mm (73.5 in). To further enhance the performance of the finishing mill, the first three rolling stands will be reinforced to withstand higher rolling forces.

Two new powerful roughing stands and a vertical edger will be installed ahead of the finishing mill. With its total draft of 100 mm, the powerful edger allows the full recrystallization of the slab edges and makes it possible to expand the capacity of the plant when producing narrow products.

The complete process control from melting to finished hot-rolled coils will be developed by Danieli Automation. The challenge is to optimize the operation between the existing and the new meltshop, while controlling the quality of the caster and QSP®. As part of the implementation strategy, the new automation system will shadow and parallel the current automation systems to allow seamless switchover to the new automation.

The automation system will be designed for integrating the Industry 4.0 concept.

“In Danieli Automation we very well aware that we are going to create a reliable plant, targeting zero down-time because it will be based on the predictive concept, designed today to be modern in the next 30 years,” said Antonello Mordeglia, president Danieli Automation. “We will predict maintenance, events, order management, and much more. Energy and utilities will be continuously adjusted to run at the lowest possible OpEx without compromising the output material quality and delivery time.”

The project will be implemented over a sequence of three carefully planned mill shutdowns. The strategy will take maximum advantage of the annual maintenance outages already planned by the plant. “The layout is conceived in a way that large parts of the new equipment can be installed and tested off-line. But, at the same time we shall plan the shutdowns for the equipment installed in-line with hourly precision.” – according to Matteo Bulfone, Danieli vice president, flat product hot rolling mills.

During the last shutdown the complete roughing mill group, previously pre-assembled off-line, will be moved in line via a lift-shift system. The foundations of the mills will be prepared under the existing tunnel furnace without interfering with the production.

With this project to convert a compact mill into a QSP® plant at Nucor Steel Gallatin, together with a high-performance meltshop, the Nucor and Danieli teams are determined to establish a new benchmark casting and rolling plant throughout the world.

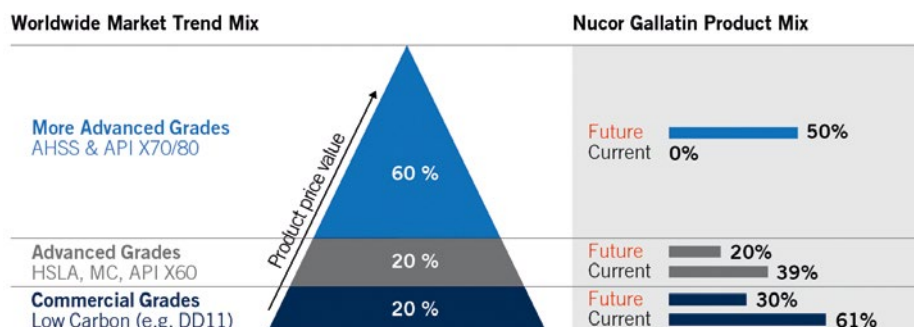

Market trend in the steel product mix (Picture: Danieli)

**Danieli**

## Extended range of products for cold strip substitutes

# Ultra-thin hot rolled strip with 0.6 mm thickness produced on Arvedi ESP line

Following on from ten years of continued development of the endless concept, this latest production record was achieved at Rizhao Steel during a test in which eight coils were produced with strip thicknesses of less than 0.8 mm.

In October 2018, an Arvedi ESP (endless strip production) line installed in a plant belonging to the Chinese steel producer Rizhao Steel Group Co., Ltd (Rizhao) produced ultra-thin hot strip with a thickness of just 0.6 mm for the very first time. Hot strip as thin as this had never before been achieved anywhere in the world. This thin strip can cover more than 80% of regular commercial cold-rolled thicknesses. This widens Rizhao's range of products, especially for cold strip substitutes.

This latest production record was achieved during a test in which eight coils

were produced with strip thicknesses of less than 0.8 mm. This production sequence involved first progressively reducing the strip thickness to 0.75, 0.7 and finally 0.6 mm, before continuing the sequence with increasing thicknesses. ESP mills are guaranteed to produce strip thicknesses of 0.8 mm, which are used industrially and traded on the market for direct applications. Whereas a strip thickness of 0.8 mm covers around 50% of cold-rolled thicknesses, a strip thickness of 0.6 mm can cover more than 80% of cold-rolled thicknesses. Conventional hot strip production has a lower

thickness limit of 1.8 mm, or 1.2 mm for special processes.

## Advancing control concepts known from cold rolling

This success was made possible by the familiar properties of the ESP process, such as an extremely high process stability accompanied by constant speeds and temperatures. At the same time, advances were made in technologies that, in their original form, had only been used in cold rolling mills for high-quality product. The "ultra-thin rolling technology" is based on control concepts applied in cold rolling technology.

The Arvedi ESP system produces hot strip directly from liquid steel in a continuous, uninterrupted production process in a linked casting and rolling mill. Mills of this type have an energy consumption and associated costs up to 45% lower than those of conventional mills with separate casting and rolling processes. They also have substantially reduced CO<sub>2</sub> emissions. The mills, with a length of only 155 m, are considerably more compact than conventional casting and rolling mills. The casting and rolling line is controlled by standardized, integrated basic (level 1) and process (level 2) automation, which ensures finely coordinated interaction of the casting and rolling processes.

The Arvedi ESP mill No. 4 is one of five casting and rolling mills that Rizhao has ordered from Primetals Technologies. It is designed for an annual production of 1.7 million t of high-quality, ultra-thin hot strip, in widths ranging from 900 to 1,300 mm. The maximum casting speed is 7 m/min, and the coil weight 28 t.

Primetals Technologies



Ultra-thin hot strip coil produced at Rizhao Steel, China (Photo: Primetals Technologies)

New perspectives to designers and manufacturers in the aerospace industry

# Weber Metals unveils new die forging press for aluminum and titanium

In October 2018, Otto Fuchs Group celebrated the grand opening of its new die forging press at the location of its U.S. subsidiary Weber Metals in Paramount, California. Completely set up by SMS group, the new press, with a force of 540 MN (60,000 short tons), is deemed the worldwide strongest hydraulic pull-down die forging press in pit-mounted design.

The die forging press, also named 60k press as it can exert a force of 60,000 short tons (U.S.), will serve Weber Metals to make products for the aerospace industry from forged aluminum and titanium. Forgings of these high-performance materials are used in the fuselage, in the wings, the undercarriage and the engines. The performance data of the new die forging press opens up completely new perspectives to designers and manufacturers in the aerospace industry for larger, weight-optimized but also structure-optimized com-

ponents that offer increased safety at less weight. In the future, such parts will allow for the design of aircrafts featuring higher transport capacities, improved safety and minimized fuel consumption. These new, larger and lighter components are key to the future of mobility. Dr.-Ing. Klaus Welsch, head of Aerospace division, Otto Fuchs KG, puts it like this: "The new forging press from SMS group is our flagship and will ensure the competitiveness and also the technological leadership of Otto Fuchs for the next 30 years."

## A heavy-weight plant for high-precision forgings

Thanks to its enormous forging power the plant can shape even new high-strength and ultra-high-strength materials. Companies able to offer such raw materials will find markets that could not be served so far.

SMS group was responsible for the mechanical equipment, electrical and automation systems, hydraulic equipment as well as the complete erection of the plant including commissioning. 9,000 t of steel

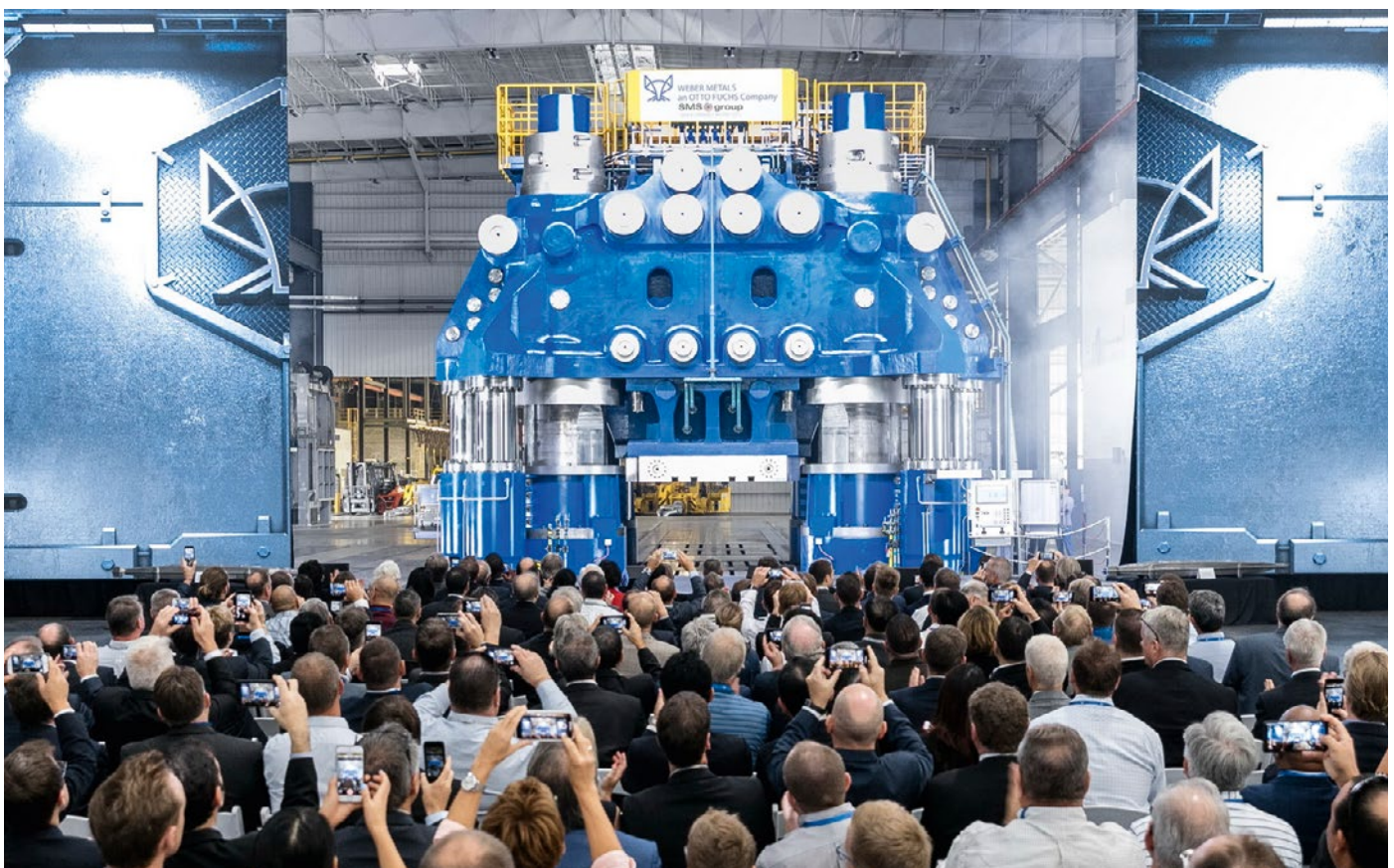

Ceremonial presentation of the 60k die forging press at Weber Metals in Paramount, California (Picture: SMS group)



One of the first parts forged on the new die forging press (Picture: SMS group)

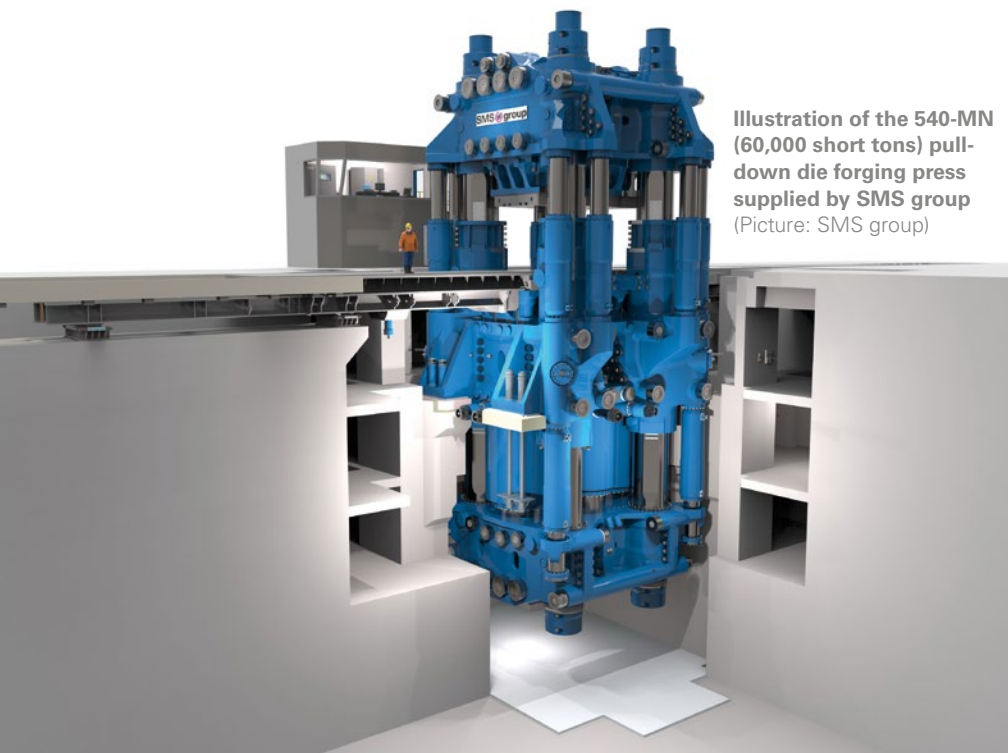

Illustration of the 540-MN (60,000 short tons) pull-down die forging press supplied by SMS group (Picture: SMS group)



The QR-Code links to a video of the inauguration ceremony ([www.t1p.de/j9xm](http://www.t1p.de/j9xm))

were used to build the press. The huge components, including 34 cast and forged parts with weight between 100 and 330 t installed in the press had mainly been manufactured in Europe and Asia and then shipped to the U.S.A. according to a masterpiece of logistics and planning. Not less challenging were the earth and installation work, and the auxiliary assembly aids specifically designed for this project.

A highlight of the press is the extremely high precision in the forging operation, which it largely owes to its balancing system with latest valve technology and highly sensitive electronics being perfectly harmonized and interacting. The press is designed for hot and cold forming and features a die clamping area of 6,000 mm x 3,000 mm. Forging of first reference pieces was also part of SMS group's supply scope. The fact that the forging results were impressive right from the beginning was a result of the meticulous planning coordination between Weber Metals and SMS group and the perfectly complementing know-how of both companies.

■ SMS group



High speed delivery system of the type to be supplied to Fuzhou Wuhang (Picture: SMS group)

## Fuzhou Wuhang to introduce thermomechanical rolling

**Fuzhou Wuhang is upgrading its rebar mill and has awarded SMS group the order to supply technology for thermo-mechanical rolling.**

The rolling mill will be laid out for an output of 700,000 t/year of rebar. SMS group will supply all key equipment including the electrics and the automation package. The plant is scheduled to be started up by mid-

2019. SMS group will use the proven loop technology, which ensures that the product stays within the required temperature range. The mill will also include MEERdrive® finishing blocks, which feature single drives and a robust cartridge-type design, as well as SMS group's HSD® high speed delivery system.

■ SMS group



GSM 200 to capacity and GFM 100 to capacity  
in operation at NAF, New Castle / PA

# GLAMA

performance  
for high productivity

## GLAMA Maschinenbau GmbH

Headquarters:

Hornstraße 19 D-45964 Gladbeck / Germany

Fon: +49 (0) 2043 9738 0

Fax: +49 (0) 2043 9738 50

Email: [info@glama.de](mailto:info@glama.de)

## GLAMA USA Inc.

768 W Bagley Road Berea, Ohio 44017

Fon: +1 877 452 6266

Fax: +1 440 201 6900

Email: [sales@glama-us.com](mailto:sales@glama-us.com)

Toll Free: 877-GLAMA66



25-29 JUNE, 2019  
Düsseldorf, Germany

Visit us at booth no. :

Hall 5 G04

**METEC**



GFM up to 150 t capacity

[glama.de](http://glama.de)



GRM up to 25 t capacity

## Digitalization in special machinery engineering

# Heinrich Georg Maschinenfabrik: From machine builder to process optimizer

Heinrich Georg GmbH demonstrates great innovative power and the ability to adapt to changing technological requirements at a recent in-house trade fair.

**M**ore than 150 customers visited the “Tech Fair” staged at Georg’s headquarters in Kreuztal on 30 October 2018. The central topic discussed was digitalization and how it may impact on its customers’ production processes. Live demonstrations of machines – including a new slitting line for strip and a CBN-based roll grinding machine of the ultragrind series – provided impressive proof of Georg’s readiness to tap the potentials of digitalization and “Industry 4.0”.

During the all-day event at the company’s headquarters in Kreuztal, the guests obtained latest information on new technologies not only from the techni-

cal papers presented, but also from live demonstrations of the machines. In two manufacturing halls, the visitors could experience live the high degree of digitalization implemented in the Georg machines and learn about current development activities of the company. As the topics of digital transformation, automation technology, preventive maintenance, condition monitoring and autonomous transport systems are of equal interest to all the customers, independent of their industry focus, the event was for the first time co-hosted by all three business areas – Finishing Lines, Machine Tools and Transformer Lines.

On several machines, Georg demonstrated how a high degree of automation and the networking of individual plant units within production lines and with higher-level systems can help plant operators optimize their processes. On a slitting line for strip of up to 2,150 mm width, which is soon going to be delivered to a customer in China, members of the Georg team showed how the availability of production plants can be improved by the implementation of condition monitoring systems. Under the headline of efficient life cycle management, they demonstrated the Georg “plant app” on a roll grinding machine, illustrating how this app simplifies production monitoring,



Roll grinding machine of the ultragrind series use comprehensive sensing equipment to optimize the grinding process (Picture: Heinrich Georg Maschinenfabrik)

maintenance and troubleshooting for the plant operator.

Based on machine data analysis functions (Big Data and Artificial Intelligence), the Georg products reduce maintenance intervals and, using latest communication technology, Georg supports its customers all over world "live" from Kreuztal.

### Progress in digital transformation

For Mark Georg, managing partner of the company, digitalization is definitely not a passing fancy: "As a family-owned business, we think in long-term perspectives. We took the decision to consistently tap the potential of the digital transformation many years ago in order to benefit from this technological trend from the very beginning. Although there is still a long way to go, our customers benefit already today from extremely efficient production processes thanks to our networked systems, comprehensive data analysis and world-spanning communication."

The live demonstrations during the Tech Fair showed how far along the road to digitalization Georg has already gone:

- Complex algorithms evaluate large volumes of machine data and derive recommendations for process optimizations and preventive maintenance from their analyses.
- Via its "Connected Service", service engineers based in Kreuztal can access machines at any place in the world to support their customers via chat as required, while their contacts at the customer's end take live videos of the situation on site with their tablets.
- Via the Georg-app, the customer can check the production and productivity status of his machine at any place and time.
- Handling robots stack plates for transformers fully automatically, and with the extreme precision and the high throughput rates demanded by transformer manufacturers.
- Autonomously driving transport platforms for loads weighing up to 120 t use laser scanners to find their way. They do not need any rails or wiring installed in the floor.

During the last few years, Georg, an original machine builder, has already come a long way as a digital company. Georg



**Mark Georg (right) during the panel discussion on topics of the digital transformation. To his left: Dr. René Gissing, member of the management of Knauf Interfer SE** (Picture: Heinrich Georg Maschinenfabrik)

has achieved most of its innovative developments by its own efforts. The fact that the company cooperates with the University of Siegen, the RWTH Aachen University, Fraunhofer Institute and other partner businesses underpins its future-oriented approach. As part of the Tech Fair event, the Georg "Think Tank" forum, a discussion platform established in 2015, invited experts from different disciplines to discuss the challenges of the future and what technologies the future may bring.

During the subsequent panel discussion with representatives of the steel industry, Mark Georg pointed out the first tangible results of the process of organizational development implemented in his highly diversified company. "As well as the great opportunities provided by our new technologies, we have succeeded in flexibly adapting our structures and processes, and aligning our way of project handling and execution to the necessities of the dynamic social and technological change."

A further, not least promising future technology was addressed at the Tech Fair: Dr. Eric Klemp, head of voestalpine Additive Manufacturing Center GmbH, elaborated on the opportunities and limits of additive manufacturing, a much discussed technology in the world of mechanical engineering. Additive manufacturing processes are expected to revolutionize the production of complex-shaped components in the very near future.

### First roll grinding machine using CBN abrasives

The "ultragrind 25" roll grinding machine in operation in the roll shop of Salzgitter AG's hot rolling mill is the first in the global steel industry to use CBN abrasives. As well as achieving a grinding throughput three times



**By using CBN abrasive tools, the roll grinding machine reduces grinding times by more than 50 percent** (Picture: Heinrich Georg Maschinenfabrik)

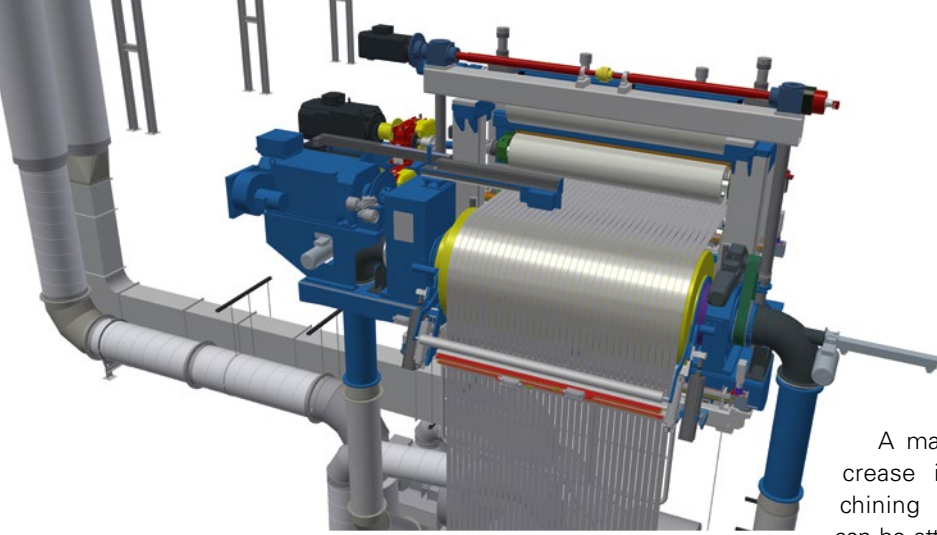

**New vacuum technology guarantees high surface quality at slitting lines** (Picture: Heinrich Georg Maschinenfabrik)

greater than the machine previously used, it dramatically cuts set-up, testing and idle times.

While in the automotive industry and other sectors CBN abrasives have become well established, in roll grinding shops for hot rolling mills there is still some way to go. In the roll shops performance features like high wear resistance and short grinding times matter more than the surface quality.

Roll grinding machines of the Georg ultragrind series perform machining and measuring within one sequence without having to reclamp the workpiece. This alone provides a significant reduction in machining times and higher efficiency compared to conventional machines. With the introduction of CBN abrasives, the company has now taken a further leap in innovation: Never before have CBN abrasive tools been used in roll shops of hot wide strip mills in the steel industry. These tools are superior to other abrasives in that they are able to machine even rolls of high-strength materials, such as HSS grades featuring a hardness between 83 and 87 Shores C, with highest precision and most efficiently.

The new machine at Salzgitter AG, which passed all acceptance tests in June 2018, can grind HSS work rolls with diameters of up to 1,000 mm and weighing up to 25,000 kg in a fully automatic process. Both conventional and CBN abrasives may be used. Michael Kotzian, manager of the roll shop in the hot rolling mill at Salzgitter, expects from the CBN technology a significant potential for improvement in roll grinding efficiency: "We know that with the investment in the Georg roll grinding machine we are pioneers in the steel industry. The results of the acceptance tests are convincing proof that the technology works. In a next step we will work with Georg and the abrasives manufacturers to sophisticate the process and advance the technology with a focus on further improving economic efficiency"

CBN-based abrasive tools. With the new machine average grinding times have been reduced by more than 30 percent. Considering also the time saved through the possibility to perform the measurements and crack testing online, roll grinding takes more than 50 percent less time now. The grinding of HSS rolls with conventional abrasive tools takes 40 to 45 minutes on average. The new machine needs only 20 minutes.

This performance improvement is largely attributable to the performance of the Georg measuring system. Both the shape and eccentricity of the rolls are measured automatically – during grinding. Also roughness measurements, crack testing and demagnetizing have been integrated into the system and are performed automatically. By bringing together CBN-based grinding, measuring performed during grinding and a CNC system adapted to the use of CBN abrasives, Georg machines also achieve higher grinding precision and a much higher surface quality than conventional systems.

As well as the use of CBN abrasives, another highlight of the Georg ultragrind 25 is that it can machine the rolls complete with chocks, including all types of pinch rolls. Thus frequent and tedious removals of chocks prior to roll grinding have become a thing of the past.

### **New vacuum breaking roll for slitting lines**

At the Aluminium 2018 trade show in Düsseldorf, Georg presented its new vacuum braking roll for slitting lines for the first time to the public. The new roll was developed specifically for strips that have to meet extremely exacting surface quality requirements. While coming with a new energy-saving vacuum technology, the new roll enables high strip speeds and optimizes the recoiling of difficult-to-process strips.

In slitting lines, braking units arranged ahead of the recoiler are often fitted with

rollers, felt pads or belts which are pressed against the strip from below and above. However, especially when slitting strip for applications that demand surfaces of highest quality, these methods entail the risk of leaving marks on the "good side" of the strip. Moreover, the felt pads are subject to intensive wear and have to be replaced at short intervals. All this impairs the productivity of the line.

The advanced vacuum braking unit achieves the braking effect by sucking the lower side of the strip against the braking roll. The upper strip side remains completely untouched, ruling out any risk of damage by mechanical components.

One of the innovative features of the unit is the possibility of setting the angle of aperture around the circumference of the roll within wide ranges: Depending on the wrap angle, the aperture may cover between 60 and 180 degrees of the roll circumference, allowing the strip tension to be flexibly adjusted to the specifics of the strip processed. Together with the high-precision regulation of the vacuum pressure, the roll thus achieves optimal recoiling with varying strip types and under varying conditions. Additionally, only those sectors of the roll length covered by strip will be activated. In this way, it achieves a dramatically lower energy consumption than conventional vacuum-based braking systems.

Georg has developed the vacuum system specially for strip thicknesses between 0.08 and 0.8 mm. It is suitable for all customary widths of cold rolled aluminium strip. A slitting line with the new technology for an aluminium producer in Asia is currently under commissioning. The line will be designed for up to 2,150 mm wide strip. The slitting line will process slit coils in widths between 15 and 2,140 mm and outside diameters of up to 2,800 mm. It has been specifically designed to recoil the slit strip at speeds of up to 600 m/min. A transfer car guides the individual slit strips automatically to the recoiler. This solution makes for smooth transfer and threading of the slit strips, and extremely short coil-to-coil times.

The vacuum equipment will be installed below the shop-floor level in a sound-proof compartment next to the looping pit, so that the noise produced by the equipment is hardly heard on the shop floor.

✉ [thomas.kleb@georg.com](mailto:thomas.kleb@georg.com)

*Thomas Kleb, head of Marketing and Communication, Heinrich Georg GmbH Maschinenfabrik, Kreuztal, Germany*





Two DCL-Lines for grain oriented electrical steel installed at Shougang Qian'an, China (Picture: Tenova LOI Thermprocess)

### Processing lines for electrical steel strip

# Technical solutions for the heat treatment of electrical steel strip

The world's leading electrical strip producers have placed their trust in tried and tested Tenova LOI Thermprocess heat treatment plants for most of their new plant and modernization projects.

Over the past 15 to 20 years, there has been a real boom in the construction of new electrical strip production lines and the modernization of existing lines. This is the result of several factors. A key aspect is the trend towards e-mobility, which has led to investments in the non-grain-oriented (NGO) strip sector. In addition, there has also been a trend towards thin strip, calling for higher production capacities. In the grain-oriented (GO) electrical strip segment, there has been growth in demand as a result of efforts to improve energy efficiency by minimizing hysteresis losses.

Some regions or countries are boosting their production capacities at an above-average rate as a result of the rapid pace of infrastructure development. In China, several entirely new electrical strip plants have been constructed, such as the plants of the Baosteel Group and the Shougang Group for example. Wuhan Iron and Steel and Angang New Steel have also expanded their capacities. In India, the JSW Group has developed new capacities and thyssenkrupp Electrical Steel has expanded and modernized its production facilities. In Europe, many existing plants have been modernized and a few new plants have

been constructed, for example for voestalpine in Linz (KGL-2) or Stalprodukt (Poland), thyssenkrupp Electrical Steel or the NLMK Group at its locations in Lipetsk and Yekaterinburg.

It is indisputable that the key component of any electrical strip treatment line is the heat treatment section, i.e. the furnace. The mechanical equipment of these lines is technologically less critical and less complicated because the lines are operated at relatively low strip speeds (up to 200 m/min). In the furnace section, special, precise temperature control, changing gas compositions and dew



**Modern ACL-Line for heat treatment of non-grain-oriented electrical steel** (Picture: Tenova LOI Thermprocess)



**DCL-Line at thyssenkrupp Electrical Steel** (Picture: Tenova LOI Thermprocess)

points, precise slow and fast cooling as well as automated operation, based on a model if possible, are important aspects. Various thermochemical treatment steps such as decarburizing and nitriding take place in the furnace sections of a strip treatment line which are linked by a number of separators.

Since 2000, Tenova LOI Thermprocess has received a total of 59 orders for electrical strip treatment lines. 33 of these orders concerned entirely new plants while 16 orders included comprehensive modernization work. 10 of the projects have not been completed yet.

For these orders the heat treatment sections for electrical steel strip have

been supplied by Tenova LOI Thermprocess and the mechanical parts have been supplied in cooperation or in a consortium with major mechanical plant suppliers such as Tenova Strip Processing, Andritz Sundwig or the SMS Group. The new ACL for JSW in India was realized entirely by Tenova.

In some cases, Tenova LOI Thermprocess was the leader of the consortium, as for the ACL-2 line for China Steel Corporation or the electrical strip treatment plants for Wuhan Iron & Steel Co. Ltd. In other cases, leading electrical steel producers such as voestalpine, Austria, chose explicitly the cooperation with Tenova LOI Thermprocess as for their new KGL-2 line constructed in 2011 to be able to realize NGO strip annealing with a strip width of 1650 mm.

One of the largest new electrical strip plants was constructed by Chinese steel company Shougang in Qian'an. All seven heat treatment lines (furnaces including control systems) were supplied by Tenova LOI Thermprocess. The contract concluded directly with Shougang covered the engineering and supply of the following types of furnace:

- two annealing and pickling lines (APL) for NGO & GO strip, each with a capacity of more than 60 t/h,
- three decarburizing and coating lines (DCL) for GO strip, each with a capacity of more than 9 t/h,
- two final annealing and coating lines (FCL) for GO strip, each with a capacity of more than 15 t/h.

A multi-stack bell-type annealing plant – with a total of three multi-stack bases – for the high-temperature annealing of GO strip completed the state-of-the-art facilities for electrical strip production at Shougang Qian'an works.

All the furnaces started production between 2011 and 2013. In the first half of 2012, the first high-grain oriented (HGO/HiB) strip material was annealed and, following a run-up phase, the projected capacity of 150,000 tonnes per year was reached in 2015. According to information provided by the customer, the plant is currently used for the production of 100% HiB grades with low-temperature plus nitriding technology.

**Tenova LOI Thermprocess**

# WORLD MARKET LEADER FOR THE HEAT TREATMENT OF ELECTRICAL STRIP (GO & NGO)

Other suppliers talk about it, we have the references!  
More than 175 references in the period from 2000 to 2016:



## Our well-known customers include:

AK Steel (USA) – Angang Iron & Steel (China) – ArcelorMittal / Aperam (various countries) – Baoshan Iron & Steel (China) – China Steel Corporation (Taiwan) – GO Steel Frýdek Místek (Czech Republic) – JSW Steel (India) – NLMK & VIZ Steel (Russia) – Shougang Iron & Steel (China) – Stalprodukt (Poland) – thyssenkrupp Electrical Steel (various countries) – voestalpine (Austria) – Wuhan Iron & Steel (China)



**tenova**  
LOI THERMPROCESS

LOI Thermprocess GmbH  
Am Lichtbogen 29 | 45141 Essen (Germany)  
Tel. +49 201 1891 1 | Fax +49 201 1891 321  
loi@tenova.com | www.loi.tenova.com

Newly developed integrated automation solution for processing lines

## Innovative electrolytic metal coating line and cold mill at Baosteel

In August 2018, an electrolytic metal coating line equipped with an integrated automation solution developed by Primetals Technologies was started up at Baoshan Iron and Steel Co., Ltd. (Baosteel) in Shanghai. This is the first application of a new automation concept specifically designed for processing lines.

The new electrolytic metal coating line for Baoshan Iron and Steel Co., Ltd. (Baosteel) in Shanghai produced the first coil in August 2018 – two weeks ahead of schedule. Utilization of the new integrated automation concept along with the powerful high-end PLCs improves considerably the performance of technological controls, whereas the new innovative human-machine-interface (HMI) concept will facilitate operation and diagnostics.

Baoshan Iron and Steel Co., Ltd. is part of the China Baowu Steel Group Corp., Ltd. and, with an annual production of 65.4 million

t (2017), the second largest steel producer in the world. In order to meet the increasing needs of tinned and chromed products, Baosteel decided to build a new combined electrolytic tinning and tin-free steel line.

Primetals Technologies' scope of supply encompassed the control system, including basic (level 1) and process automation (level 2) as well as the HMI system of the complete fully automated line, including entry section, entry looper, electrolytic tinning section, tension leveler, and the exit section with magnetic belt transfer. Additionally, 347 motor drives and 251

gear motors were supplied. A separate safety control system was installed. The innovative automation concept for processing lines developed by Primetals Technologies is introduced with special attention placed on latest hardware developments with unification of equipment. This contributes to hardware standardization, simplified maintenance and improved system diagnostics. The line is highly automated, using robots in the entry and exit sections. Due to the high automation level, no entry operator and thus no entry operation room is required anymore.



The first coils produced in the electrolytic metal coating line at Baoshan Iron and Steel Co., Ltd. (Baosteel), Shanghai (Photo: Primetals Technologies)

The line has a design capacity of 200,000 t/year. At a process speed of 450 m/min, materials with thicknesses ranging from 0.12 to 0.36 mm and widths between 700 and 1,230 mm may be processed. The Baosteel electrolytic metallic coating line is a combined processing line for electrolytic tinning and tin-free steel production (ETL/TFSL). The products are primarily intended for food industry packing cans.

### Cold mill can operate in both, reduction and temper mode

Also, a newly-built double cold reduction (DCR) mill supplied by Primetals Technologies commenced operation. The DCR mill is designed to process 205,000 t of cold strip per year and is also part of the tinplate product structure optimization project at Baosteel.

The DCR mill can achieve a maximum line speed of 1,500 m/min. It consists of a two-stand universal cold mill and is designed to perform double-cold reduction as well as one-stand temper rolling. In the DCR process, the annealed strip, after reduction in a tandem cold mill, is reduced on the No. 1 stand and temper rolled on the No. 2 stand. This process imparts the strip with its prescribed mechanical strength. In stand No. 1, work rolls with two different diameters can be used. In one-stand temper rolling, the strip is temper rolled in stand 2 to the prescribed



Front view of Baosteel's new double cold reduction mill (Photo: Primetals Technologies)

elongation ratios to obtain the desired mechanical characteristics.

The DCR mill processes strip produced by a pickling line/tandem cold mill (PLTCM). Entry strip gauges are between 0.17 mm and 0.55 mm. Exit gauges range from 0.12 mm to 0.36 mm. Strip width may vary from 700 to 1,230 mm. At a coil diameter of

2,000 mm, maximum coil weight amounts to 24.15 tons. Steel grades include DR7 to DR10. The processed strip will be used for the production of beverage can, metal caps, electrical components, for example.

Primetals Technologies

## Primetals Technologies offers subscription licenses for caster process optimization systems

**Primetals Technologies has started to offer subscription licenses for process optimization systems to operators of continuous casting machines, enabling caster operators to benefit from continuous developments, improvements and inventions.**

Under these licenses, new releases, upgrades, updates and fixes are implemented on a regular basis. The modularity of the system allows single functions and models to be subscribed or cancelled, depending on what is required. Newly developed features and functions which become available over time can be implemented on request.

The included service package provides remote support in terms of troubleshooting, consulting, training, tuning or tweaking. New functions become easier affordable as the customers only pay for what they have subscribed for. Clear and attractive annual fees allow financing out of continuous casters' operational expenses and predicting costs from year to year. Less allocation of capital is required when subscribing the system. The first customer worldwide to sign up for a subscription license is a US-based steel maker.

Primetals Technologies



Representation of the continuous casting process with a process optimization system (Picture: Primetals Technologies)

Digital assistance system improves yield

# Marcegaglia to strengthen cold strip production with a new rolling mill at the Ravenna site

Marcegaglia Ravenna S.p.A. will install a new high-performance compact cold strip plant. The Italian company has contracted SMS group for the complete supply of a two-stand reversing cold mill of CCM® (compact cold mill) design.

Marcegaglia's headquarters are located in Gazoldo degli Ippoliti, in the Mantua province in North Italy. At the Ravenna production facility Marcegaglia produces cold rolled carbon steel sheets and strips for a wide range of industrial applications. The company has started with the planning for a new cold strip rolling line that after completion will start up operation in spring 2020.

As a high-performance mill, it is designed to process a comprehensive material mix, including high-carbon and duplex steels, chrome-manganese alloyed steels, and silicon steels. The annual capacity is about 550,000 tons.

Depending on the product mix, it rolls strips with widths of between 750 and 1,570 millimetres and entry thicknesses ranging between 0.60 and 5.00 millimetres. The minimal achievable final thickness is 0.23 millimetres.

The compact cold mill (CCM®) will be equipped with one pay-off and two reversing reels. Both rolling stands will be realized in four-high design.

It will be possible to operate the mill with work roll sets of two different diameters. Excellent strip quality, high productivity and efficient rolling operations are provided by proven SMS group rolling technologies, like e.g. the CVC®plus (continuously variable crown) roll shifting technology, which, in combination with work roll bending, ensures a wide flatness setting range. One dry strip system per stand will be provided to remove surplus emulsion from the strip surface. The plant will be equipped with the X-Shape flatness measuring and control system, which, together with multizone cooling, ensures optimal flatness results of the finished strip.

The new cold strip line will be operated with the X-Pact® automation package, which provides a consistent and complete system solution for the high-performance control concepts and strategies. In addition to the features aimed at optimizing plant efficiency, the TRC® (total roll gap

control) assistance system developed by SMS group is going to be applied for automatic and stabilized strip threading into the pre-set optimized roll gap. The assistance system makes for stable rolling right from the strip head end, increasing the material yield as a result of reduced strip bulging at the head and tail ends. The very high automation level of the cold strip mill is an important step towards digitalization and adaptability to future requirements. The new cold rolling facility at Marcegaglia Ravenna S.p.A. is expected to start operation in April 2020.

■ SMS group

Design concept of the new high-performance compact cold strip plant (Picture: SMS group)

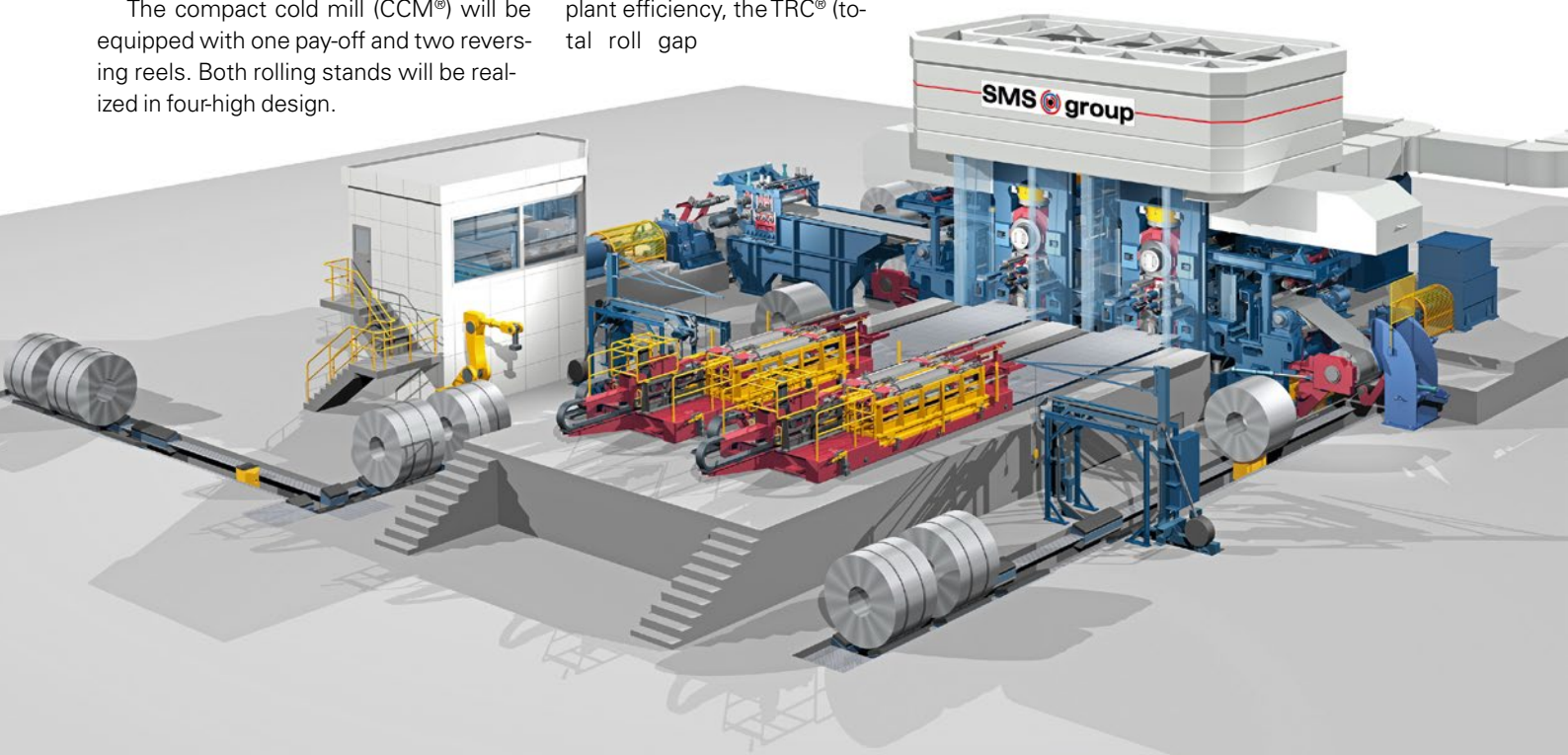

## Dimension measurement of metal tubes

# High-precision laser-based measurement of internal tube contours

For the first time, such a measuring system has been designed to be used in the rugged environment of industrial tube manufacturing.

The new laser-based gauge developed by Dango & Dienenthal Umformtechnik measures the internal contour of tubes and pipes contact-free and with highest precision. The system is capable of measuring the shape, e.g. ovality, over the complete internal circumference or specific surface features, such as weld seams.

The recently patented system measures the internal contour of seamless metal tubes and longitudinally welded pipes in a non-contact process based on the circular laser triangulation technique. It captures the contour along the complete tube length and generates a complete 3D image of the internal tube wall from the measured data. In longitudinally welded pipe making, the

system can be employed – before welding – to capture the dimension of the weld gap, and – after welding – to measure the weld seam.

The system comes with different measuring ranges for tube diameters between 100 and 1,000 mm. It measures the internal contour at 2,048 points gaplessly distributed around the complete internal circumference of the tube. This corresponds to an angular resolution of 0.2 degrees. The distance measurement takes place with a resolution of one per mille of the measuring range.

The new gauge works on the principle of laser triangulation: A laser, accommodated in the measuring head, projects a line

onto the complete internal circumference of the tube wall. The camera, which is also installed in the measuring head, captures the line at 2,048 points distributed around the internal circumference. The software derives the internal tube contour by calculating and aggregating the individual distances from the axis.

Mounted on a carrying arm, during the measurement the measuring head moves through the tube along the central axis, capturing up to 90 profiles per second. Based on these profiles, the complete internal contour can be represented in 3D. Denis Albayrak, sales manager at Dango & Dienenthal Umformtechnik, describes the benefits for producers and processors of tubes and pipes: "For the first time ever, the internal contour of tubes and pipes can be measured with a system designed for use in the rugged environment of industrial tube manufacturing. Made for a measuring range of up to 500 mm radius and highest measuring precision, the gauge is the perfect choice for the exacting requirements of the tube and pipe industry."

**Dango & Dienenthal Umformtechnik GmbH**

**A camera captures the line projected by a circular laser onto the internal tube wall**  
(Picture: Dango & Dienenthal Umformtechnik)

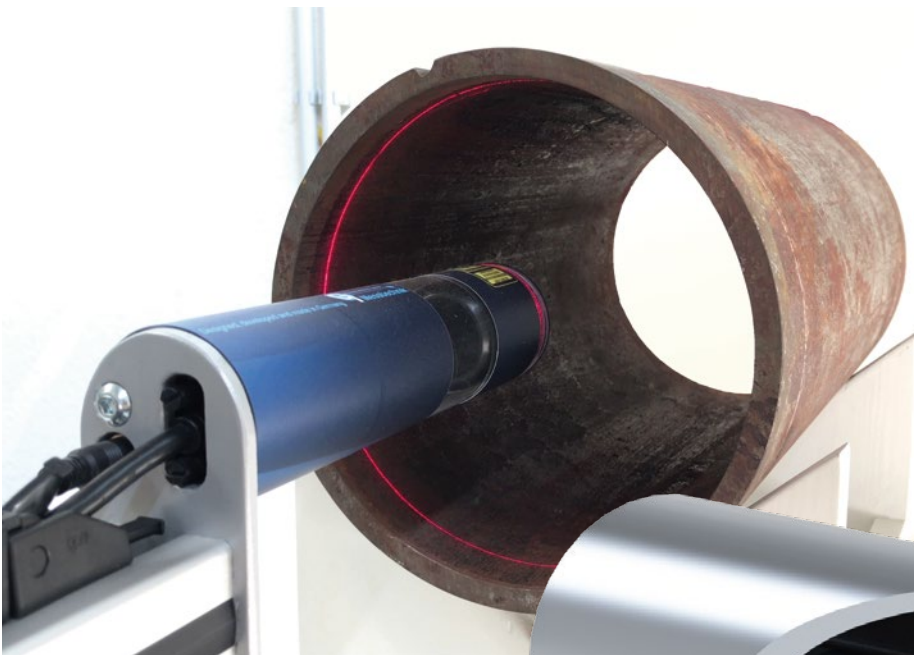

The new laser triangulation system is capable to measure tubes with a diameter range between 100 and 1,000 mm (Picture: Dango & Dienenthal Umformtechnik)

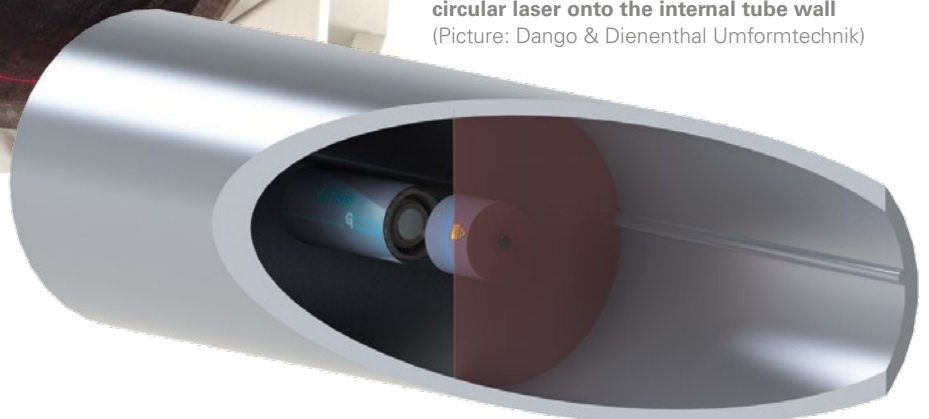

## Digitalization: design thinking

# Smart Alarm – an intelligent alarm and maintenance system

The alarm and warning messages which are already available in the existing automation system are processed, analysed, enriched with additional information and visualized in a smart way. Maintenance managers are enabled to better plan and execute the maintenance activities and thus increase plant availability.

In the steel and metal industries, a high degree of automation is already present and in the course of the 4th industrial revolution, even more sensors are installed. This progressive digitization process creates an enormous amount of data, which often leads to an information overflow. Systems are needed which deal with the data in an intelligent way, extract the contained information and, combined with expert know-how, create value.

### Development of Smart Alarm

Smart Alarm has been developed by including potential users from several steel and metal producing companies along the entire process chain. The underlying pragmatic methodology is called Design Thinking. It comprises six phases [2]. The Design Thinking process can be split in two parts. In the first part, the focus is on defining the question as openly and unbiasedly as possible and without being limited by existing solutions. In the second part, ideas are found and substantiated to solutions. The entire process is iterative, so that the questions can be redefined during the solution finding process. With this user-centric approach and the integration of the detailed

feedback of users and partners, practice-improved products can be created which focus on only relevant and existing problems and create an added value right from the start.

By performing several user interviews and workshops, the most painful problems of the potential users have been jointly defined. It turned out that one of the reoccurring issues is the huge number of alarms that causes an information overload. Alarms are not considered or even overlooked. Thus, the HMIs are lacking an overview of the alarm handling. That includes a missing prioritization of alarms, flickering alarms which cover the important alarms as well as problems with allocating the origin of the alarm to the physical machine or plant part.

Apart from the lack of transparency in the alarm screens, finding relevant information about the alarms is also found to be difficult. Valuable time is lost in searching for drawings or documentation in folders which are often not close to the machine where the problem occurred. With the know-how of handling a certain alarm concentrated in the heads of few experienced people, pictures of the alarm messages were distributed via WhatsApp groups to find the solution to the problem. In some cases, these solutions were collected

in Excel-sheets to make them available for the next time the situation occurred.

Depending on the size of the plant, communication problems were listed as well. Time was lost between the first occurrence of an alarm or warning and the informing of the relevant maintenance personnel. Reasons for this varied between not knowing if or whom to inform and just ignoring the warning until the machine really stopped working.

### Benefits of Smart Alarm

The common problems mentioned above cause the producers of steel and metal to waste time and therefore to lose money. In a continuous development process, Smart Alarm was developed and applied to them, giving benefits to their production:

- increase plant availability,
- focus and avoid information overflow,
- preserve and share know-how.

First of all, it helps the maintenance team to increase the equipment availability, increasing the focus and avoiding information overflow. To account for the inhomogeneous know-how distribution in most companies, having some very experienced people

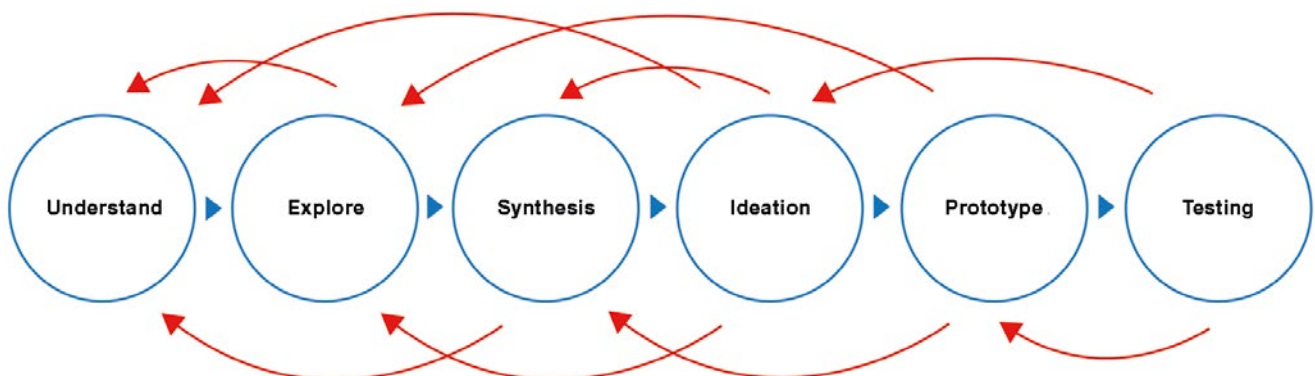

Six-phases scheme of the Design Thinking process [2] (Picture: SMS group)



among newly employed or personnel from other areas, Smart Alarm also allows preserving and sharing know-how.

**Focus on relevant alarms.** As basic value adding functionality, the alarms are arranged according to the machine tree and the start and stop event of the alarm is transformed into a bar at the time axis. Therefore, one can see intuitively the duration of the alarms, the number of occurrences and the location in the plant at a glance. This intelligent visualization permits the detection of the cause of a disturbance fast and effectively. Different plants, machines or equipment from the entire site can be aggregated in one visualization, which is accessible from everywhere via a web interface – including mobile devices, which become more and more important to the maintenance. Further features allow hiding alarms according to personal tasks or to react on temporary situations in the plant. So e.g. the hydraulic maintenance officer can hide all non-hydraulic alarms, leaving only alarms on which he needs to act. Now, if an alarm is shown in his Smart Alarm screen, he can drill down to the machine causing the alarm with few clicks and start solving the problem before the machine actually fails. Another example are alarms which are permanently active while their root cause is known. This could be a sensor which is about to be replaced in the next maintenance stop. While in the commonly existing system, this alarm is constantly active and blocks the view to other relevant alarms, with Smart Alarm it can easily be hidden temporarily without any changes in the automation system.

**Solution management.** Now, after having decided which alarm is relevant, the responsible person can propose his best practice solution to an occurring alarm to share his knowledge. Special expertise is retained and knowledge becomes available for every other operator or maintenance manager. This is how the solution feature enables constant knowledge transfer documenting solutions for alarms right where they occur. The advantage of Smart Alarm to other expert systems is the ease of use. Since the system is available to all users anywhere, everyone can easily add their

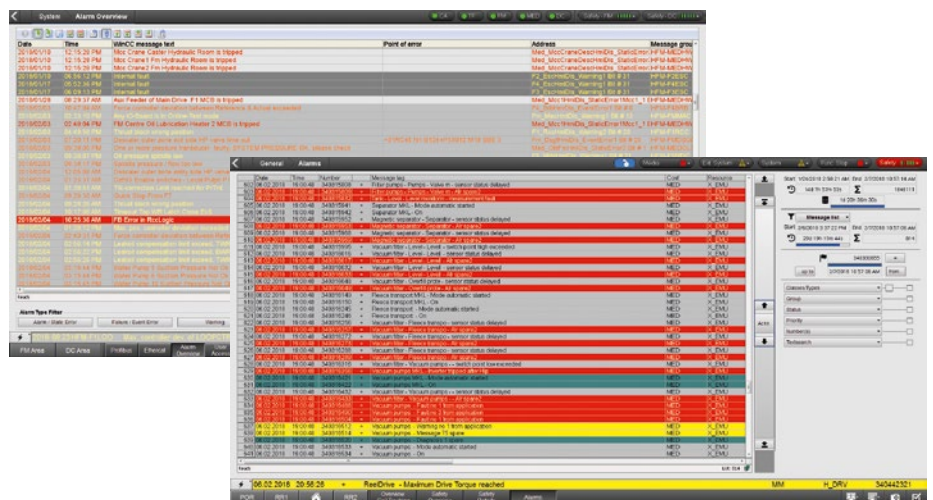

A common pain-point found is a very unintuitive visualization of the alarm messages. Important alarms get overlooked and correlations are nearly impossible to find (Picture: SMS group)

solution ideas to the system and build up the know-how continuously. In addition, the solution advices are available right where one needs them, since they are connected to an alarm causing the problem.

**Notification of critical alarms.** Another commonly observed problem concerns the communication. The operators focus on the production and often do not have the time to react on all alarms and warnings arising in the systems. Sometimes, they even lack the knowledge which alarms are relevant and who is to inform when. Partly, this problem can be reduced in Smart Alarm by the increased focus and by adding solutions. But often it shortens reaction time if the responsible person is automatically informed by the system about critical alarms or warnings. With Smart Alarm, the responsible maintenance manager or supervisor is directly informed via short message or e-mail, which guarantees a faster detection of an adequate solution to the alarm and reduces the risk of downtime. Notifications quickly direct the problem to the right person, the expert in the corresponding field. In case of special situations, using the e-mail notification, the head of maintenance or plant manager can easily and conveniently get an overview of the machine's or plant's health status.

**Analytic evaluation of alarms.** Observation of the results after maintenance activities – this analytics feature gives an

overview of the historic data and helps to improve maintenance for fewer downtimes and cost reduction. Performance becomes measurable and maintenance managers can examine how effective maintenance activities have been. Based on historic data, occurring alarms are visualized in a period before a maintenance action and can be compared to the occurrences of any alarm after such an intervention. Even more effectively, checking the alarm trends for increasing alarm occurrences, the maintenance personnel can detect were problems are arising, manage their maintenance activities accordingly and even prevent the equipment to fail unexpectedly during production. Rendering this feature even more effective, maintenance times can be excluded from the evaluation, as alarms occurring in these times are usually not representative. In case the machine status is available in the automation system, it can be automatically be integrated in Smart Alarm. Alternatively, maintenance times can be manually entered.

**Supporting mobile maintenance.** Mobile maintenance becomes more and more important and mobile devices likes tablets find their way into the steel plants. To support this trend, Smart Alarm can recognize specific plant parts using QR-codes and support the maintenance engineers with alarm data and solution advices right at the machine.

*Dr. Jesper Mellenthin, Tommy Goslicki, SMS digital GmbH, Düsseldorf, Germany*

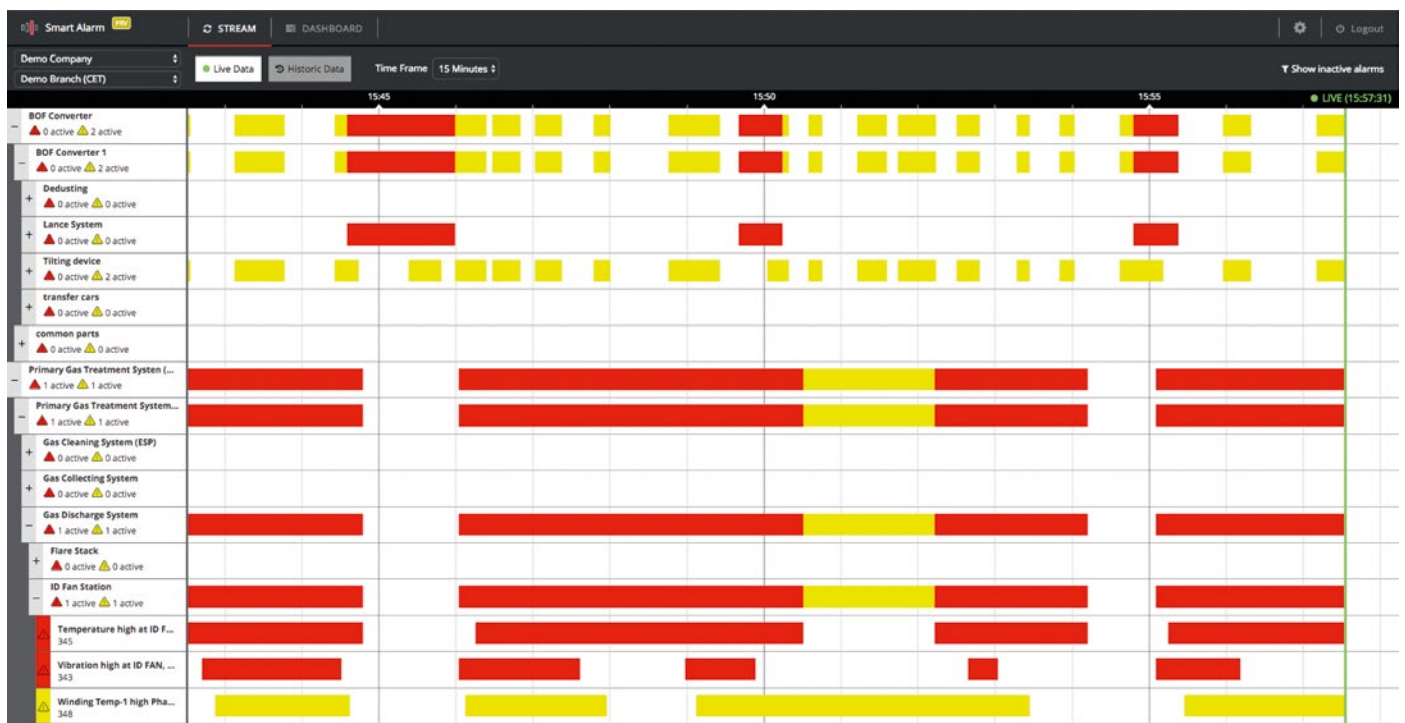

Main functionality of Smart Alarm is to visualize the alarms and warnings in an intelligent way (Picture: SMS group)



Augmented reality provides relevant machine information available in a very convenient way (Picture: SMS group)

## Outlook

Using the available data to predict failures is the next step in the development process. With machine learning and artificial intelligence algorithms, it is currently investigated if alarm patterns can be detected. This helps on the one hand to

reduce the alarm flood and to focus on really important events again. On the other hand, by detecting patterns, one can also predict the occurrence of certain alarms with a certain probability. If the predicted alarm is known to be critical, it will avoid unexpected equipment failures and hence increase the productivity.

## Conclusion

SMS digital has used innovative methodologies of Silicon Valley to develop Smart Alarm, an intelligent alarm and maintenance management system. The system collects relevant alarms and warning messages from the existing automation systems without the need of additional hardware or sensors. Different machines or plant parts from arbitrary suppliers and with different automation systems can be accumulated in one central visualization which is accessible from everywhere and to everyone in a web interface, accessible also from mobile devices. It is easy to install, and the steel and metal producers can profit from its benefits without long engineering phases. For example, the complete installation takes only a few hours and can be performed by the steel producer alone having only remote support from SMS experts. The entire project time from first discussions until running of the system can be handled in less than one week.

Smart Alarm allows increasing the equipment availability by avoiding downtimes, by focusing on relevant alarms and warning and by sending automatic notifications in the case of critical events. In the case of a downtime, the root cause can be found faster and the personnel is supported with possible solutions to the problem. Also, the maintenance activities can be optimized by an analytic evaluation of the long-term stored alarms. And the journey continues: Using the collected data, it is currently tested if machine learning algorithms can determine alarm patterns and predict the occurrence of alarms, hence prevent machine failure.

## References

- [1] W. Brenner, T. Naef, B. Pukall, B. Schindlholzer, F. Uebernickel, "Design Thinking - Das Handbuch", Frankfurter Societäts-Medien GmbH, Frankfurt am Main, 2015
- [2] J. Gürtler, J. Meyer, "Design Thinking", GABAL Verlag GmbH, Offenbach 2013
- [3] B. Hollifield, "Understanding and Applying the ANSI/ISA 18.2 Alarm Management Standard", PAS 2010
- [4] A. Baker, A. Evora, "SCADA alarm best practices", Affinity Energy [https://www.affinityenergy.com/smart-scada-alarm-management-part-3-9-best-practices/], 2016, access 24.1.18
- [5] Brian Pagán, "Lean Startup MVP: How To Make Meaningful Products", [https://brianpagan.net/2015/lean-startup-mvp-how-to-make-meaningful-products/], 2015, access 07.02.18

STEEL + TECHNOLOGY - The new technical journal

GET ALL THE IMPORTANT  
STEEL INDUSTRY INFORMATION  
ANYWHERE, ANYTIME VIA APP



free samples  
fulltext search function  
read issues offline  
buy single issues

DOWNLOAD NOW FOR FREE:



FREE SAMPLE PRINT ISSUES AND FURTHER INFORMATION AT  
[WWW.HOMEOFSTEEL.DE](http://WWW.HOMEOFSTEEL.DE)



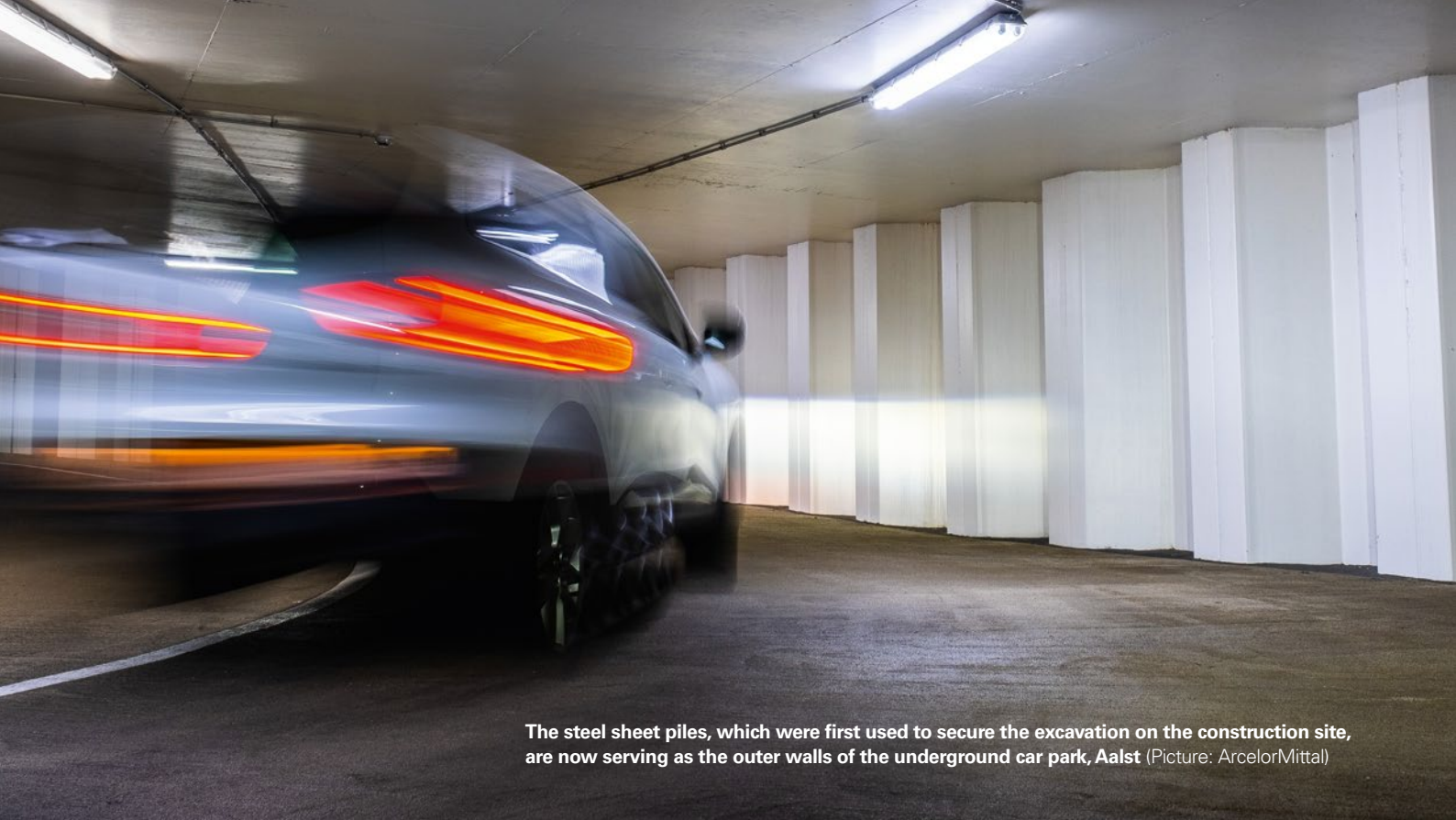

The steel sheet piles, which were first used to secure the excavation on the construction site, are now serving as the outer walls of the underground car park, Aalst (Picture: ArcelorMittal)

**Quick, cost-effective and eco-friendly completion of construction projects**

## ArcelorMittal starts new initiative on solutions in sheet piles

At Bauma 2019, the world's leading construction machinery trade fair in Munich, Germany, ArcelorMittal launches its new initiative "ArcelorMittal Solutions – Think steel first!" unveiling the true potential of steel sheet piling solutions to the construction business.

Whether it be protecting people and land from flooding, or whether it be building bridges or quay walls to ensure smooth mobility and transportation: steel sheet piles from ArcelorMittal offer smart and efficient solutions – easy and fast to install, long-lasting and sustainable over the entire life cycle of the infrastructure. At Bauma 2019, the world's leading construction machinery trade fair from 8 – 14 April in Munich, ArcelorMittal launches its new initiative "ArcelorMittal Solutions – Think steel first!". During the trade fair in April, ArcelorMittal will present its sheet piling solutions.

Focused around four application domains, ArcelorMittal's unique sheet piling solutions offer exceptional benefits that help improve everyday life and ensure quick, cost-effective and environment friendly completion of the construction projects.

### Water transport solutions

Building deep maritime infrastructure such as quay walls and breakwaters with ArcelorMittal unique steel sheet piling solutions, like the HZ<sup>®</sup>-M combined wall systems and the AS 500<sup>®</sup> circular cells, the life-time cost of the project can be drastically reduced. AMLoCor<sup>®</sup> corrosion-resistant steel grades reduce the effect of corrosion by a factor of up to 5 times, allowing for longer-lasting infrastructure. Made from fully recycled and recyclable steel, covered by an Environmental Product Declaration, steel sheet piles help reducing the environmental impact of the projects.

### Hazard protection solutions

Dykes and flood protection barriers made from steel sheet piles are one of the most

efficient ways to protect against flooding and rising sea levels. Requiring little equipment, sheet piles can be easily installed even in remote locations, with particularly short installation times thanks to AZ<sup>®</sup>-800, the widest sheet piles on the market.

ArcelorMittal's engineering and R&D teams continuously develop software and design methodologies with research institutions and consultants. They help designing steel sheet piling structures as well as simulating the effects of earthquakes and fire, respectively.

### Mobility infrastructure solutions

Steel sheet piles are an excellent option for building bridges, underpasses, underground car parks, foundations, retaining walls or noise barriers. Short installation times and efficient vibration-less installation

techniques help delivering projects faster, saving costs and minimizing the impact on the community. For example, building permanent bridge abutments with steel sheet piles significantly reduces the traffic disturbance and achieves up to 15% cost savings over the entire lifetime of the structure. The connection between concrete and steel can be designed with VLoad software. Building Information Models (BIM) digital files are available for ArcelorMittal sheet piles.

### Environmental protection solutions

When faced with pollution, containment is vital. Steel sheet piles are used on a temporary and permanent basis in landfill deployment, soil remediation, riverbed cleaning operations or pollution containment. Impervious enclosures can be created to safely retain contaminated material and devise a remediation plan, thanks to ArcelorMittal's

wide range of sealing solutions including AKILA®, an environmental-friendly sealant suitable for contact with drinking water. Finally, ArcelorMittal offers customized solutions, tailored to the needs of their customers. Outstanding support via technical teams, available around the world, underlines the unique competitive edge of ArcelorMittal steel sheet piling solutions, leading to the conclusion: ArcelorMittal Solutions – Think steel first!

### The sheetpiling sector at ArcelorMittal

ArcelorMittal is the world's largest producer of hot-rolled steel sheet piles, cold formed sheet piles, bearing piles and foundation solutions. These are produced at Belval and Differdange in Luxembourg, Dabrowa Górnicza in Poland (for U-shaped hot rolled sheet piles), 'Palfroid' in Messempré, France (for cold formed sheet piles)

and Dintelmond in the Netherlands (steel tubes for foundations). ArcelorMittal Belval is the rolling mill of hot rolled steel sheet piles offering the largest product portfolio and has been playing a leading role in the development of piling technology for over 100 years.

Steel is essential to the modern world. Strong, flexible, adaptable as well as fully reusable and recyclable, it does not only contribute to the circular economy, but it is the material of choice for sustainable construction solutions in today's world. ArcelorMittal offers worldwide comprehensive services and customized support to all the parties involved in the design, specification and installation of sheet and bearing piles, such as consulting engineers, architects, regional authorities, contractors, academics and their students.

■ *ArcelorMittal*

## Chengdu Changfeng places order for new EAF and ladle furnace

**Chengdu Changfeng Steel Group has placed an order with Primetals Technologies to supply an EAF Quantum electric arc furnace and a ladle furnace for its plant in Dujiayan city, Sichuan Province.**

For the new electric arc furnace and the twin ladle furnace, Primetals Technologies will supply the complete mechanical and electrical process equipment and the automation technology. This includes the automated scrap yard management, the automated charging process, automation of the oxygen injection and sand refilling, as well as the Level 2 automation.

The EAF Quantum developed by Primetals Technologies combines proven elements of shaft furnace technology with an innovative scrap charging process, an efficient preheating system, a new tilting concept for the lower shell, and an optimized tapping system. This all adds up to very short melting cycles.

■ *Primetals Technologies*



An EAF Quantum electric arc furnace in operation (Picture: Primetals Technologies)

## Dutch Steel Award 2018

# Award-winning steel-built railway bridge in the Netherlands

The longest railway bridge in the Netherlands has been recognized for its innovative and efficient design, enabled by the use of thermomechanically rolled steel.

In the course of a large-scale extension of the A1 motorway east of Amsterdam, it had become necessary to replace the Muiderberg railway bridge, a

concrete railway viaduct. The impressive new bridge, a steel construction, was completed in 2016. Now the bridge has been honoured with the Dutch Steel

Award 2018 in the infrastructure category.

The project was challenging in various respects: for example, the bridge was to span the motorway without intermediate supports but yet should be of streamlined and light design, and the prefabricated parts were to be easy to assemble on site.

## Weight savings through S460M/ML-grade thermomechanically rolled steel

Spanning 255 m, the 17 m wide and 55 m high “Zandhazenbrug”, as the Dutch call it, is the longest railway bridge in the Netherlands and one of the largest arched bridges in Europe. Dillinger supplied 8,200 t of the total 8,400 t of steel from which the bridge is built, about 7,000 t of which S460M/ML-grade thermomechanically rolled steel.

Using heavy plate of this grade enabled the weight to be reduced by almost 30%, while achieving the set goals in terms of ease of transport and assembly, and free spanning length. Thanks to the choice of the steel also the use of raw material and the total welding effort could be reduced, having a positive effect on the overall energy consumption.

These and other efficiency, innovation and design-related aspects, along with the architectural performance, have now been honoured with the Dutch Steel Award. The Muiderberg railway bridge joins the list of award-winning projects for which Dillinger supplied steel: for example, the exhibition halls and multi-storey car park of the Stuttgart trade fair centre, in France the Gustave Flaubert lift bridge in Rouen, the Simone de Beauvoir pedestrian bridge in Paris and the Pierre Mauroy Stade in Lille, and last but not least the Lochkov Valley Bridge near Prague.



The Muiderberg railway bridge in the Netherlands (Photo: Vliegfeld Hilversum)

### Project data of the railway bridge

Location: A1 motorway, Muiderberg, Netherlands  
 Contracting authority: Rijkswaterstaat/ProRail, Amsterdam/Utrecht  
 Architects: ZJA Zwarts & Jansma Architects, Amsterdam  
 Design: Iv-Infra, Haarlem  
 Implementation: SAAone  
 Steel construction: Victor Buyck, Eeklo, Belgium  
[www.nationalestaalprijs.nl](http://www.nationalestaalprijs.nl)

AG der Dillinger Hüttenwerke

Deutsche Edelstahlwerke (DEW) speeds up additive manufacturing

## DEW Printdur® for complex steel components from the 3D printer

Deutsche Edelstahlwerke (DEW), a company of the Schmolz + Bickenbach Group, is taking its additive manufacturing activities to the next level with its Printdur metal powder portfolio. DEW is already including interested customers in the prototyping process and is developing complete manufacturing processes with them – from the initial idea and alloy design through to the finished product.

Everybody is talking about additive manufacturing. Unlike mechanical manufacturing processes such as milling or turning, additive manufacturing builds up the component layer by layer. This method provides considerable flexibility in component design. A high-grade starting powder is essential.

As an established powder manufacturer for 3D printing, Deutsche Edelstahlwerke (DEW) is now making a big push by speeding up the next stage of development with its Printdur metal powder portfolio. The company supplies a wide range of iron-, nickel- or cobalt-based atomized metal powders in its Printdur portfolio. The raw materials are liquefied in an induction oven and then added to a gas atomization system. This is where the particles are shaped into spheres, guaranteeing excellent flow behaviour and effective dosage control for the powder. This means DEW's own powders are eminently suitable for additive manufacturing.

### From the idea to the development to the product

Additive manufacturing with metal materials is primarily used in the aerospace industry, medical technology, toolmaking and lightweight automotive construction. DEW aims to work as closely as possible with the customer on the manufacturing process. Dr. Horst Hill, head of Special Materials at Deutsche Edelstahlwerke, explains: "We help our customers with implementation – from their own alloy idea to the printed end product. We take a step-by-step approach: we define the requirements, develop the material, carry out powder atomization, try out and optimize the material and, ultimately, also even help to recycle the powder. We are

**"We define the requirements, develop the material, carry out powder atomization, try out and optimize the material and, ultimately, also even help to recycle the powder."**

*Dr. Horst Hill, head of Special Materials at Deutsche Edelstahlwerke*



The Printdur portfolio comprises a wide range of iron-, nickel- or cobalt-based atomized metal powders (Photo: Deutsche Edelstahlwerke)

extremely flexible with regard to the order amount: we supply both tiny amounts and large volumes on an industrial scale."

Deutsche Edelstahlwerke manufactures all products on state-of-the-art additive manufacturing systems (AM systems) – from the initial powder and semi-finished part through to the additive-man-

ufactured component. DEW customers benefit from an extensive product variety in additive manufacturing. The company already offers more than 200 materials in metal powders.

**I Deutsche Edelstahlwerke (DEW)**

## Steel powder for sintering

# Kobe Steel to expand steel powder production

Japanese Kobe Steel will install another reduction furnace to enable higher treatment temperatures than the current furnaces. It will also install another mixer to increase production capacity of certain powder grades.

**K**obe Steel, Ltd. plans to invest approximately 1.8 billion yen (approx. 14.38 million euros) to increase the production capacity of its steel powder plant in Takasago, Hyogo prefecture in western Japan. The annual production capacity of steel powder products will increase to 110,000 t from the current 96,000 t per year. Mass production is scheduled to begin in the April – June quarter of 2021.

Kobe Steel's steel powder products are mainly used in powder metallurgy to make automotive sintered parts such as engine parts and transmission parts. In the steel sinter powder field, Kobe Steel estimates that it has nearly a 50 percent share of the domestic market, making it the top producer in Japan. Steel powder products of high acclaim are its original high-performance SEGLESS® KP and KS series having high compressibility and machinability, which contribute to high strength, and the SEGLESS® graphite segregation-free steel powders.

With car production forecast to increase over the medium to long term, demand for steel powders is anticipated to grow in the future, leading to Kobe Steel's decision to increase the production capacity of the steel powder plant. Kobe Steel will install another reduction furnace to enable higher treatment temperatures than the current furnaces. It will also install another SEGLESS® mixer to increase production capacity of SEGLESS®.

Of the total production capacity of 110,000 t per year, SEGLESS® will comprise 60,000 t per year, an increase from the current 40,000 metric tons per year.

Through this investment, Kobe Steel will be able to further provide a stable supply of steel powders to customers. At the same time, it will be able to better respond to their diverse needs using equipment that can produce high-performance steel powder products.

Kobe Steel, which entered the steel powder business in 1968, was the first to introduce an atomization process in Japan in which high-pressure water is sprayed onto molten metal, turning it into a powder. The process enables Kobe Steel to produce outstanding steel powders of high purity, high compressibility and high density. In addition to steel powder for powder metallurgy, other major products include steel powder that remediates contaminated soil and ground water called ECOMEL™ to prevent the spread of toxic substances such as heavy metals and VOCs (volatile organic compounds); magnetic steel powder called MAGMEL™ for use in motors and reactors; and other distinctive powders for use in hand warmers and deoxidants.

▮ *Kobe Steel, Ltd.*



Steel powder and application examples: sintered parts for automotive use (Picture: Kobe Steel)

## The sinter metals technology

**Powder metallurgy.** In powder metallurgy, metal powder is pressed and compacted into a mould and sintered to make a high-precision part. In comparison to the machining of steel, powder metallurgy offers high yield as parts with complex, near-net shapes can be manufactured.

**Graphite segregation free treatment.** Graphite is mixed with steel powder to improve the strength of sintered parts. As the specific gravity of graphite is low and its particle size is small, simply mixing the graphite leads to easy separation and segregation, resulting in variation in the composition of the part. To improve this condition, segregation-free treatment enables the graphite to adhere to the steel powder.

**Reduction furnace and mixer.** A reduction furnace is a heat treatment furnace used in the finishing stage of steel powder production. A mixer can be used for the segregation-free treatment of graphite powder mixed with steel powder.



## Low heat input for stable welded joints

# Process-reliable welding of steel and aluminium parts

The thermal joining of different materials such as steel and aluminium is particularly challenging due to the different physical and chemical properties of the materials. One solution to these challenges is the Cold Metal Transfer (CMT) process developed by Fronius. Automotive industry supplier Magna Steyr has taken CMT and developed a technology that not only makes it possible to manufacture bodywork parts much more cost-effectively, but also allows weight savings to be achieved too.

Car body manufacturers in the automotive industry are increasingly relying on a combination of different materials – and with good reason. The weight of the vehicles can be reduced considerably by using materials such as aluminium or fibre-reinforced plastics, which has a positive effect on performance and fuel consumption. It would also be hard to meet the ever more stringent exhaust emission regulations without these advances in lightweight construction. Modern vehicles therefore tend to have an ingenious mix of materials, right down to the finest details – every individual part is designed to be as

light as possible yet still provide optimum functionality. However, joining these materials, with their very different properties, poses a huge challenge.

### Use of steel and aluminium in automotive lightweight construction

Steel and aluminium is one of the most frequent combinations of materials to be joined in automotive lightweight construction. To reduce costs, manufacturers weld flange components made of aluminium to galvanized steel plates, so that they can be

joined using the conventional, cost-effective spot welding process on the bodysell production line. However, the different physical and chemical characteristics of these two materials, such as their thermal elongation, heat conduction and corrosion resistance, must be taken into account. These have a negative effect on the quality and strength of the welded joint. The formability in subsequent production processes is also very limited.

The reason for this restricted formability lies in what is known as the intermetallic phase, which forms where the two materials touch and fuse together when they are



With the CMT welding process, steel and aluminium can be joined reliably and efficiently (Picture: Fronius International GmbH)



Expensive joining processes such as punch riveting become a thing of the past (Picture: Fronius)

welded. This layer is brittle and susceptible to cracks and pores, which impairs the stability of the joint.

### A "cold" welding process improves the stability

International automotive industry supplier Magna Steyr was keen to address this problem. The company, which is headquartered in Graz, Austria, develops

and produces individual components and complete vehicles, and uses lightweight construction methods for its vehicle bodies. In order to lower the production costs for steel-aluminium weldments, Magna Steyr examined the joining process in great detail and came to the conclusion that the temperature has a critical influence on the weld seam quality.

The heat input during welding plays a significant role in determining the thickness

of the intermetallic phase. In the trials carried out by engineers, Magna Steyr discovered that ideally this should not exceed ten micrometres to ensure the joint is stable. To achieve this, the experts had to control the temperature progression in an optimal manner, keeping it above the melting temperature of aluminium but below the vaporization temperature of the zinc layer applied to the steel plates. In most arc-welding processes, this is simply not possible, but Magna Steyr finally found the solution they needed in Cold Metal Transfer (CMT), the "cold" welding process developed by Fronius.

The CMT welding process significantly reduces the heat input in comparison to other MIG/MAG processes. The secret lies in the digital process control, which automatically detects short circuits and then helps to detach the droplet by retracting the wire: during welding, the wire moves forward and is pulled back again as soon as the short circuit occurs. As a result, the arcing phase is very short and the heat input reduced. Using this process, the energy input can also be continuously adapted to suit the component to be welded. Users benefit from spatter-free material transfer and optimum welding results. CMT is therefore ideal for welding steel joints using CO<sub>2</sub> and other shielding gases. It is also intended for use in the joining of steel and aluminium, as

Car body manufacturers benefit from combining different materials (Picture: Fronius)



the steel base material is only wetted by these braze-welded joints and does not melt. This means it perfectly meets the requirements for use in the automotive industry.

### Intermetallic phase thinner than ten micrometres

With the help of the CMT welding process and by optimizing the welding wire, Magna Steyr has developed a technology for joining steel and aluminium efficiently and reliably. Being able to set the welding parameters precisely keeps the intermetallic phase thinner than ten micrometres. The mechanical properties of the joint meet all the requirements placed on them. Compared to conventional processes, CMT also offers the advantage

that welding no longer needs to be carried out on both sides, but now only on one side, which lowers costs and reduces the workload. Additionally, expensive joining processes such as punch riveting also become a thing of the past – leading to even greater cost-effectiveness.

Magna Steyr won the 2017 Automotive Innovations Award from the Center of Automotive Management (CAM) and PricewaterhouseCoopers (PwC) Germany for its innovative joining technology. Magna was recognized as the most innovative automotive supplier by impressing the jury in the chassis, car body and exterior category.

■ *Fronius International GmbH, Magna Steyr*

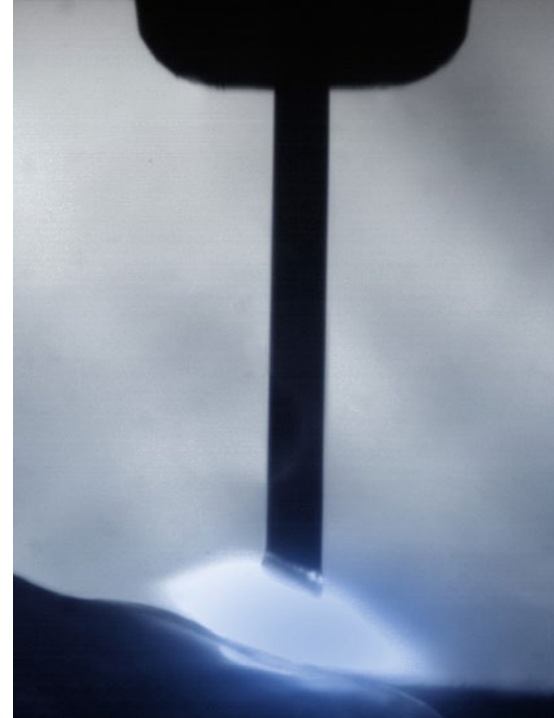

In the CMT welding process, the arcing phase is kept very short and the heat input reduced. The energy input can be continuously adapted to suit the component to be welded (Picture: Fronius)

## AMAG Rolling to modernize continuous heat treatment line

**Aluminium producer AMAG Rolling has awarded Primetals Technologies an order to modernize continuous heat treatment line No. 2 at its Ranshofen plant in Austria.**

This project involves renewing the electrical and automation equipment as well as replacing and adding instrumentation and control components. Also the safety equipment will be brought up to the state-of-the-art. The goals of the modernization are to use standardized solutions to simplify maintenance, increase availability, and install safety equipment complying with the requirements of the machine safety ordinance.

The main components of the continuous heat treatment line run by AMAG Rolling are a coil preparation system, a strip infeed section with uncoiler, a stitcher and strip looper, a strip flotation furnace, the strip outfeed with strip looper, an inspection section and a coiler. Primetals Technologies constructed the plant at the end of the 1990s. It now contains obsolete components, which make optimal maintenance more difficult in respect of availability and the procurement of spare parts.

Primetals Technologies will replace the control systems and controls for strip processing and the furnace, switchgear, cables



Continuous heat treatment line No. 2 operated by aluminium producer AMAG Rolling GmbH is going to be modernized by Primetals Technologies (Picture: Primetals Technologies)

and sensor system, and equip the plant with new visualization and diagnostic facilities. Furthermore, control containers, hydraulic components, railings and doors with guard locking will be added. The comprehensive renewal of the electrical systems and automation with standardized solutions will significantly simplify maintenance. The renewal and expansion of the safety equipment will create another significant benefit by simplifying the operation and maintenance of the plant by making operating conditions safer. A standard, modular

automation system will be installed with separate processors for process and safety functions. The order also includes the risk analysis, hardware and software engineering as well as manufacturing, documentation, system test, installation, training and commissioning. The agreed implementation time is 17 months. Completion of the modernization project is scheduled for in the fourth quarter of 2019.

■ *Primetals Technologies*

## Digital transformation in steel trade

# Klöckner & Co enters into a strategic partnership with Axel Springer hy

Axel Springer hy and Klöckner & Co are going to jointly offer their expertise gained from the digital transformation of their own companies as consulting services to other entrepreneurs.

**A**xel Springer and Klöckner & Co have successfully realigned their respective businesses to meet the demands of the digital world. Both companies have now joined forces to share with other companies what they have learned.

Through kloeckner.i, Klöckner & Co has forged ahead with its own digital transformation, to the extent that digital channels already account for around a quarter of group sales. The company plans to increase this to 60% by 2022. In addition, Klöckner launched the XOM Materials platform, which makes it possible to digitally trade in a wide range of materials. The platform is also open to the company's competitors.

Set up in early 2017, Axel Springer hy is an Axel Springer SE Group company.

Axel Springer generates more than 80% of its operating profits through digital offerings. These include numerous disruptive platforms that enjoy success across the globe. The Axel Springer hy experts assist businesses with their digital and cultural transformation as well as in developing and implementing their strategy.

### Combining digital strengths

The partners bring complementary strengths to this new alliance. Axel Springer hy employs more than 40 digital experts who provide consulting services to customers outside of Axel Springer SE in the fields of analysis, strategy, cultural change, company building, investments and ventur-

ing. Since being set up in February 2017, it has handled 90 projects for 52 customers.

In Berlin, almost 90 kloeckner.i employees are dedicated to the digital transformation of Klöckner & Co, as well as platform design, construction and operation. They are also responsible for driving cultural change within the group. This team's expertise will now for the first time be available on the open market.

Axel Springer hy and Klöckner's digital team will remain legally independent entities that offer their joint services to customers from a single source. Axel Springer hy CEO Christoph Keese says of the partnership: "We are unified in our entrepreneurial approach. We at Axel Springer hy and our colleagues at Klöckner are driven by an entrepreneurial spirit and the desire to effect change. Everything we offer to our customers, we have already tried and tested ourselves – and we never stop learning. We are aware of the difficulties associated with digital transformation and will not rest until we have found the right solution for our customers. We complement our Klöckner colleagues well and are now fluent in the languages of both heavy industry and the digital sector. As a team, our aim is to score successes for our clients." Gisbert Rühl, CEO of Klöckner & Co SE explains: "The two companies' respective capabilities are the ideal match. With kloeckner.i, we have successfully developed B2B platforms using our own team – from concept idea through design to programming – while at the same time ensuring integration with our core business. We are now giving other companies access to the knowledge we have gained as pioneers in this field, combined with Axel Springer hy's exceptional expertise. The hy team are leading consultants when it comes to disruptive strategies and their implementation within companies."

### kloeckner.i

To bring all projects within the group-wide digitalization strategy together under one roof, Klöckner & Co launched kloeckner.i in 2014 – a dedicated centre of competence for digitalization in Berlin. kloeckner.i's main tasks are the development, testing and group-wide rollout of digital solutions together with management of the group's online marketing activities. In the future, digital consulting services will also be provided to companies outside the group. Through integration into Klöckner & Co's proprietary B2B marketplace, kloeckner.i additionally provides consulting customers with easy entry into e-commerce.

### Axel Springer hy

A legally independent subsidiary of Axel Springer SE, Axel Springer hy GmbH was set up in early 2017 and assists businesses with their digital transformation. The company meets the growing need for customized concepts to meet disruptive challenges and transform them into entrepreneurial successes. More than 40 digital experts support clients with strategy development and implementation as well as cultural change. Spread across numerous industries, the client base spans large medium-sized companies to international groups.

■ *Axel Springer hy GmbH, Klöckner & Co SE*

Market insights

# Global market for electrical steel

Electrical steel is a valuable steel variant which has acquired its cardinal position in the global market due to the rising demand for electric motors and electric cars.

The steel industry has witnessed hegemony of large players, especially in the last decade or so. However, in addition to the oversupply of steel, changing global trade dynamics have significantly impacted the conventional supply-demand scenario of steel, including electrical steel. While the steel industry is witnessing an oversupply of low-cost steel, growing demand for electrical steel has led manufacturers to ramp up their production capacities.

In particular, demand surge for cold rolled grain-oriented electrical steel is currently fulfilled by only a handful of players who have the capacity and technology for cold rolled grain-oriented production. A five-fold cost of electrical steel as compared to hot rolled coil steel used in car manufacturing and consumer durable explains the hegemony of the big players who hold half the global revenues in electrical steel market place.

Demand for non-grain oriented electrical steel is likely to witness a surge on the back of growing adoption of electric and hybrid vehicles that consume a considerable amount of non-grain oriented electrical steel. Increasing interest of industry giants in auto electrification and exponential growth in the production of hybrid and electric vehicles will present a considerable demand for non-grain oriented electrical steel in the future.

## Capacity expansions of GO electrical steel variants

Electrical steel is also known as silicon steel, lamination steel, relay steel or transformer steel. Its properties enable application of electrical steel in the electrical and electronic industry for manufacture of transformers, motors and inductors.

Among the two types of commercially distributed electrical steel – non-grain oriented (NGO) and grain-oriented (GO) variants, demand for grain-oriented electrical steel is gaining significant momentum. An extensive application of grain-oriented electrical steel in the energy sector, particular-

ly in distribution transformers and power transformers can be attributed to the demand surge. The excellent anisotropic magnetic property of grain-oriented electrical steel to the rolling direction perfectly serves the energy sector need of low power loss during efficient energy conversion. Identifying the considerable sales of GO products within the category of most technologically advanced and highest-efficiency electrical steel, manufacturers are engaged in the expansion of GO production capacities.

- In April 2018, thyssenkrupp initiated production operation of grain-oriented electrical steel for the first time in India – to meet the growing demand for the electrical steel variant in rapidly growing electricity demand in the country.

- AK Steel, the only provider of grain-oriented electrical steel products in the North America region so far and a significant exporter of grain-oriented electrical steel across the globe launched a new grain-oriented electrical steel product for high and ultra-high voltage power transformers in May 2018.

- In June 2018, Big River Steel, the ambitious steel producer from Arkansas (USA) announced the investment of US\$ 1.2 billion for the expansion of the steel and electrical steel production facility. The investment is expected to explore possibilities in grain-oriented electrical steel production and a line of next-generation coating.

## Trade disputes to spur economies towards strengthening domestic production

Electrical steel markets in fast-growing economies have been import-oriented. Flooded with low-cost steel, exports from China dominated this supply chain, however, current trade disputes have spurred a courtship behavior across world economies to sustain their domestic steel industries. According to the World Steel Association data, approximately 17% of the global steel export is projected to witness diversion towards attractive steel markets. Influenced

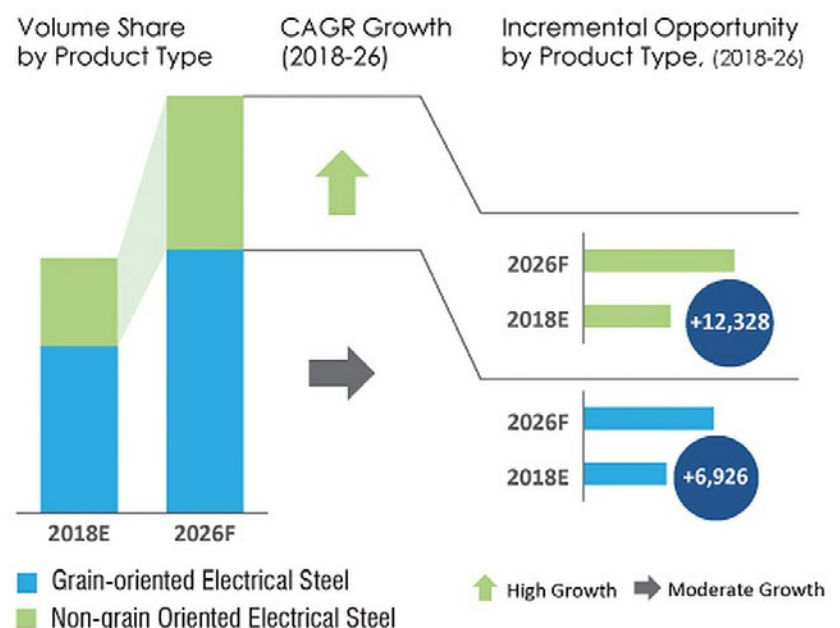

Electrical steel market analysis and forecast by product variant (Picture: Fact.MR)

by steel tariffs, economies are carving their own ways of increasing domestic production of electrical steel.

### Forecast and trends

According to a research published by Fact.MR [1] the demand for electrical steel was evaluated at 16 million tonnes in 2018. This study highlights a steadily rising consumption of electrical steel due to soaring demand from the automotive industry, predominantly from the electrical vehicles sector. It has been examined that the overall growth of the electrical steel market is attributed to several factors such as rising interest of steel companies to put up with evolving trends in the concerned marketplace.

For the forecast period between 2018 and 2026 it has been revealed that the glob-

al market for electrical steel is projected to develop at over 8% compound annual growth rate until 2026. It is expected that almost 900,000 tonnes of electric steel would be traded in 2019 at a year-on-year growth of 6.7%. In addition, the report preaches the growing interest of electrical steelmakers to enhance product quality. Also, demand for non-grain oriented electrical steel will experience a stable rise.

Considering fully and semi-processed NGO electrical steel variants, the research admits that semi-processed variant accounted for a major consumption share in 2017 and the statistics remained unaffected in 2018. To be precise, the forecast is expected to stay optimistic of NGO electrical steel being the prime steering factor for the global electrical steel market attributed to the growing application of NGO electrical steel across the automotive industry. Moreover,

the use of commercial NGO electrical steel for multiple applications such as mid-sized motors and transformers is also expected to act as a primary motivator for the global market for electrical steel.

The report states that the marketplace for electrical steel is observing consolidation of domestic markets as a result of ongoing trade quarrels. Keeping a good check on the scenario, investments by steelmakers are primarily centred on improving the quality of electrical steel and fulfil evolving regional demands.

| *Fact.MR*

### Reference

[1] Electrical Steel Market Forecast, Trend Analysis & Competition Tracking - Global Market Insights 2018 to 2026. Fact.MR, Nov 2018

## Measuring inhalable dust content and fraction that may reach the alveoli

**A stationary tester VC25 JI developed by Jung Instruments measures particulate matter and the total dust content at workplaces. A new sensor, manufactured exclusively for Jung Instruments, takes precision of flow rate measurement to the next level. The instrument complies with all commonly applied standards as it uses proven, IFA-licensed sampling heads.**

Dust pollution legislation requires that in order to comply with dust limits at workplaces the dust content measurement has to be carried out with appropriate precision right next to the workers or directly at the emission source. The new VC25 JI dust collection system developed by Jung Instruments is a stationary sampling unit designed for the measurement of the dust load at workplaces such as for welders, or of the kind found at mixing and filling plants in a wide range of industries. The system measures the inhalable dust content (specified in IFA standard 7284) and the respirable fraction that may reach the alveoli (specified in IFA standard 6068) according to EN 481, using sampling heads for dust and particulate matter licensed by the German IFA Institute for Work Safety.

Central elements of the new instrument are the robust high-precision flow rate meter, manufactured exclusively for Jung Instruments, and the new, extremely user-friendly

electronics. The electronic system is designed to always keep the flow rate at exactly 22.5 m<sup>3</sup>/h, independent of ambient temperature or flow resistance variations. The instrument comes with a software for self-diagnosis to monitor the filter condition. Fault messages, e.g. about an obstructed or defective filter, are indicated on the LCD. Thus the instrument combines new technology for flow rate control and for facilitating handling with tried and tested methods for dust measurement.

### Existing measuring heads can be continued to be used

According to Erwin Jung, founder and managing director of Jung Instruments, his customers benefit not only from the new technology of the instrument: "Many companies use dust sampling systems that have already reached their economic end of life, but not so the measuring heads that work with the samplers. The new VC25 JI is the solution many operators have been waiting for: they can now continue using the existing measuring heads." The cartridges accommodating the flat filters are easy to handle and can be conveniently taken or shipped to a laboratory for subsequent gravimetric and chemical analyses.

| *Jung Instruments GmbH*



**Stationary tester VC25 JI equipped with a sampling head for dust content measurement** (Photo: Jung Instruments)

## Raising the bar for faster processes

# Steel merchant Kicherer implements an innovative warehouse for bars and bundles

Instead of the planned expansion of existing warehouses, the company decided in favour of a completely new building with a new bar warehouse, in particular considering a much faster handling of goods. Kasto has supplied a honeycomb storage with over 10,000 cassettes including a distribution system for bundles.

Things were once again getting tight at medium-sized steel merchant Kicherer in Ellwangen, Southern Germany. Expansion of the range of products and increasing aspirations for ever shorter delivery times had made a more efficient warehouse indispensable. The many years' partnership was just one of the reasons that the company decided on a flexible, high-performance bar storage and distribution system from Kasto.

"We had a great range of products, but needed far too long to load the lorries," says Eberhard Frick, managing partner of Friedrich Kicherer GmbH, summing up the initial situation. Specifically, a system was required which was significantly faster than the existing stacking cradle system along with an expansion of the existing steel centre. Right from the initial calculations, it was clear to those concerned that not only the storage capacity but also the material flow would have to be optimized. It was therefore decided to build a new, second steel centre along with an office and multifunctional block. In order to achieve an optimum storage solution, Kicherer consulted two well-known suppliers of bar storage warehouses – one of which was Kasto.

The history of Kicherer with its long-standing tradition began 300 years ago. Founded as a nail maker in the centre of the town Ellwangen, Friedrich Kicherer took over the business in 1884, built it up into an ironmongery and household goods store, and transferred it to his daughters Auguste and Maria. In 1950, Ernst Frick joined the company to support the existing management. Seventeen years later, he took complete control of "Friedrich Kicherer Eisenwarenhandlung" and developed it into a wholesale company. In 1978, and in 1989 and 1992, Eberhard, Hans-Jörg and Gunter joined the management of their parents' company.



The project participants from Kicherer are proud of the new honeycomb warehouse (from left): Günther Seibold (project team), Simon Utz (IT manager), Hans-Jörg Frick (CEO), August Ehrsam (project team), Eberhard Frick (managing director), Maximilian Utz (IT director), Paul Rieger (CTO) (Picture: Kasto Maschinenbau GmbH & Co. KG)



The new „unicompact“ honeycomb warehouse provides more than 10,000 cassettes (Picture: Kasto Maschinenbau GmbH & Co. KG)



Final stop for the manipulators: loading area (Picture: Kasto Maschinenbau GmbH & Co. KG)

“One will win,” says Eberhard Frick, recalling the motto of the three brothers regarding the economic situation at the time. The newly opened connection to the motorway network increased the competitive pressure on the steel merchants. “At first it appeared that the competition would win,” explains the managing partner. But by the skilled expansion of the portfolio and optimization of the logistical processes, the family company grew to become a leading supplier of steel, iron goods, building products and structural elements. The most recent company history is characterized by new buildings, the acquisition of land, expansion and modernization. In 2014, the management team was supplemented by fellow partners Friederike and Daniel Frick, thus laying the foundations for securing the company’s succession.

Today, Kicherer is one of the largest medium-sized steel merchants in Germany and employs more than 350 staff members. Modern logistics and warehousing technology enable a turnover of 210,000 t of steel per year. Six Kasto automatic storage systems and 44 cranes optimize the processes. The storage experts installed the first of these in Ellwangen in 1995. Over many years of collaboration, this was sup-

plemented by racking systems for tubes, stacking cradles for structural steel profiles, angles and boiler tubes, and an “uniline 3.0” sheet metal store with 610 cassettes. These investments were mostly driven by the objective of expanding the range and providing faster deliveries.

### Objective: significantly faster material handling

Kasto was once again awarded the latest project, a bar storage system with central loading station. The innovative and flexible solution convinced Kicherer as well as the solidarity, punctual deliveries and positive experience gained by the steel merchant on previous projects with the Achern-based company, both at a personal and technical level. Other requirements included stable and reliable operation as well as a seamless connection to the existing IT system, as Kicherer had been relying on paperless product management since 1995. The loading time was also to be considerably reduced, as Hans-Jörg Frick explains: “At the moment, our lorry drives through seven halls for loading. If everything goes well, this takes 75 minutes. The objective is to reduce the loading time to less than an hour.”

The new solution is based on a “uni-compact” storage system which, with a height of 15 m and a length of 115 m, has space for around 10,000 cassettes. Each cassette can accommodate material up to six metres in length and can carry a load of up to 3.4 tonnes. Fast storage and retrieval are made possible by the five storage and retrieval machines (SRM) which serve three aisles of racks. At the same time, the second SRM, as a slave in one racking aisle, undertakes predominantly storage and exchange orders between the honeycomb storage systems, sawing and secondary picking orders. The small approach dimensions of the storage and retrieval machine ensure that as much space as possible is used for storage purposes. The SRMs approach the storage locations at up to 180 m/min, thus making the bar stock speedily available at the output stations on the “goods-to-the-person” principle. Directly connected to the system are three “Kastowin F” bandsaw machines. In order to transport the picked materials to the loading station automatically, Kasto has installed two manipulators on separate rails. From these, the bar stock travels to one of 25 loading stations via a conveyor system. A station with a packaging machine is also provided for wrapping with stretch film. The system is designed for extremely high availability.

The IT departments of Kicherer and Kasto have jointly modelled all components of the new logistics systems in a unified software package. This is also a mobile version of the “Kasto logic” warehouse management system. As well as storage and picking, dispatch has also been incorporated, including a dispatch inspection system. “Every bundle that has been picked is scanned again on loading, and automatically marked as loaded in the material requirements planning software,” explains Maximilian Utz, IT expert at Kicherer. Every single step the material goes in the warehouse can therefore be viewed at any time. This simplifies operation, avoids errors, and enables Kicherer to ensure its high delivery quality and speed, even with a growing product range.

press@kasto.com

Stephanie Riegel-Stolzer, member of the management board, Kasto Maschinenbau GmbH & Co. KG, Achern



## Warehousing and logistics

# IFOY award nomination

The Irish forklift manufacturer Combilift has come out as a finalist in one of the most prestigious international awards in the materials handling industry.

Combilift's Combi-PPT powered pallet truck with 8,000 kg capacity is one of three products shortlisted in the Warehouse Truck category for the IFOY Award (International Intralogistics and Forklift Truck of the Year). A jury of 29 journalists and editors from leading logistics media across nineteen countries and four continents will also personally test and evaluate the nominated equipment for qualities such as technology, design, ergonomics, safety, marketability, customer benefit and sustainability. Sponsor of the IFOY contest is the VDMA Materials Handling and Intralogistics Association.

### Maximum safety and manoeuvrability

The Combi-PPT is a high performance pedestrian operated powered pallet truck with a range of capacities up to 16,000 kg, which enables the safe and secure trans-

portation of very heavy loads without the need for a ride-on forklift. The features – which include Combilift's unique, patented multi-position tiller arm – and design ensure optimum visibility of the load and surroundings for the operator and guarantee maximum safety in areas where other personnel may be present, in busy production plants for example. Its manoeuvrability enables efficient and productive operation in confined spaces.

"We are delighted to be one of the 'chosen few' for this important award and we look forward to demonstrating the ca-

**"We are delighted to be one of the 'chosen few' for this important award and we look forward to demonstrating the capabilities of the Combi-PPT to the judging panel."**

*Martin McVicar, managing director of Combilift*

pabilities of the Combi-PPT to the judging panel," said Combilift managing director Martin McVicar.

The mission of the International Intralogistics and Forklift Truck of the Year (IFOY) Award is to identify and recognize the year's best intralogistics products and solutions as well as engage in activities in order to assess outstanding technical and strategic achievements in intralogistics as well as generate stimuli for innovation.

Combilift



The forklift truck nominated for the award (Photo: Combilift)

## Digital classrooms – the new way of learning

# Training with virtual and augmented reality

In early December 2018, SMS group opened its first digital classroom in Mönchengladbach, Germany. Here, SMS group customers can now experience an entirely new way of interactive learning.

The use of virtual and augmented reality applications (VR and AR) makes for highly effective learning, as processes, such as complex maintenance activities, can be perceived and experienced with a very high immersion factor. The simulated environment looks and feels – to a degree – like the real workplace. As training on the virtual model does not interfere with a plant's real production, the lessons can take place at any time. Another important aspect of this learning method is that the participants do not have to worry about the risk of error or damage.

Karsten Weiß explains: "TECademy is an international training centre for customer staff. As well as training aimed at

familiarizing operators with new plants and equipment, TECademy also offers a range of specialized training courses on selected technology-related, maintenance and plant engineering topics. The programme is complemented by e-learning classes scheduled at various dates. We also offer individualized courses catering to specific training needs and requests from our customers."

### Example of a training course: Maintenance of a hydraulic pump

By using virtual and augmented reality, training for the company's customers

becomes yet more interactive. During the classes use is made of special augmented and virtual reality goggles. The image the trainees see through their AR or VR goggles is also displayed on a large screen so that other people present in the room can experience the training live as well. Via the AR goggles, additional information can be added to the spectator's field of vision, superimposing the image of the hydraulic pump.

Different scenarios can be played through, such as the steps to be taken to disassemble and reassemble the pump. It is also possible to zoom in on an exploded view of the equipment including dynamic parts (e.g. rotating parts). In this way the wearer of the AR goggles receives infor-



AR and VR provide multi-faceted options for experiencing live how technology and processes work (Picture: SMS group)

mation on functional details not contained in conventional drawings or not visible when looking at the equipment from the outside.

"Using AR and VR technology, those participating in our training courses experience a computer-aided extension of reality. This makes training much more efficient," explains Karsten Weiß. Components, including the appropriate kinematics, can be rendered from 3D plant drawings. The trainees may use their hands to simulate mounting activities, such as the tightening of screws. In an AR training environment, the staff can go through complete maintenance procedures without having to visit the real plant, which often would not be possible in real operation anyhow.

Another advantage is that these goggles can be used not only in the digital classroom, but also at the customers' facilities. Interdisciplinary participants such as mechanics, E&A specialists or process engineers will be able to understand the "other" faculties and their tasks more easily. Additionally, the goggle is a highly flexible and constantly expandable tool to introduce new content.

"We look forward to holding the first training courses with this tool and further digital media, such as VR and tablets, in the near future," says Karsten Weiß.

✉ [karsten.weiss@sms-group.com](mailto:karsten.weiss@sms-group.com)  
 Karsten Weiß, head of TECademy,  
 Technical Service division, SMS group



The image seen by the wearer of the AR/VR goggle is displayed on a large screen for the other trainees present in the room (Picture: SMS group)

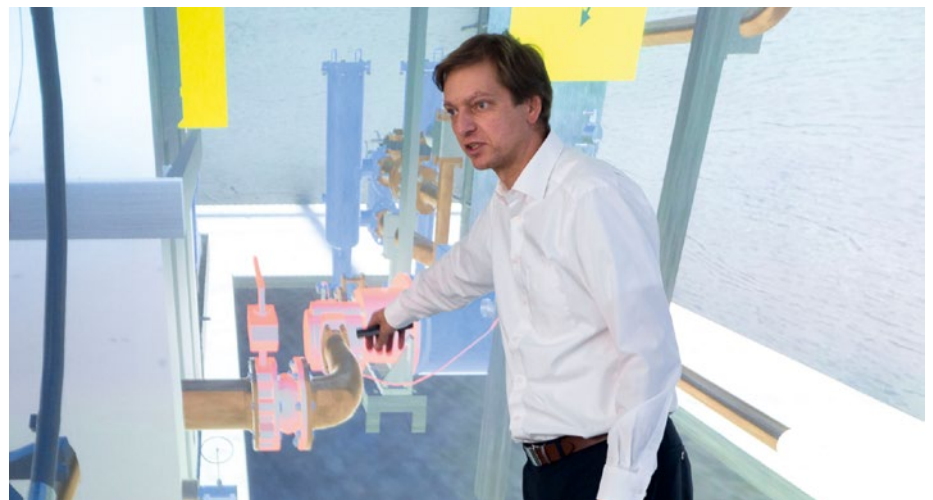

"Interactive digital 3D technology makes training much more efficient," says Karsten Weiß, head of TECademy (Picture: SMS group)

## Growing market for prefabricated building and structural steel in the Emirates

**According to a report by ResearchAndMarkets.com, the prefabricated building & structural steel market in the United Arab Emirates is expected to grow at a CAGR of 7.2% during 2019-2024, reaching a value of US\$ 1,400 million by 2024.**

The "UAE Prefabricated Building and Structural Steel Market: Industry Trends, Share, Size, Growth, Opportunity and Forecast 2019-2024"

report has segmented the market on the basis of product type, including prefabricated building and structural steel. Currently, prefabricated building represents the largest segment, and is further segregated into floors and roofs, walls, staircases, and panels and lintels. Similarly, the structural steel segment includes H-type beams, columns, I-type beams and angles.

One of the major factors driving this market is the development of a general Construction

Index in the country which aims to encourage the adoption of advanced methods of construction using prefabricated components. The report has also analysed the competitive landscape of the market and provides the profiles of the key players operating in it.

✉ [ResearchAndMarkets.com](https://www.researchandmarkets.com)

## Safety at the workplace

# Virtual reality in the field to train maintenance staff at SSAB

Nordic steel company SSAB gives virtual reality an honest try. The VR model of a walking beam furnace was developed together with the University of Ylivieska, Finland.

At the Raahe (Finland) hot strip mill SSAB will test the use of virtual reality to improve safety in maintenance work. Working in collaboration with Centria University of Applied Sciences in Ylivieska, SSAB Raahe has created a virtual model of the walking beam furnace, where slabs are reheated for rolling at the hot strip mill. Using the virtual reality, training participants can familiarize themselves with the maintenance area beforehand to identify potential safety issues.

The virtual model of the walking beam furnace highlights safe access routes and also the points to be aware of, such as

descaling hatches and burner locations. With virtual glasses, training participants know to pay attention to these and other safety aspects during their virtual tour of the furnace.

Using virtual modelling to improve safety is the first step being taken at SSAB Raahe

**“VR allows our maintenance people to try out beforehand – as if they would step inside – and learn about the safety issues ahead of time.”**

*Pekka Paganus, Maintenance director at SSAB Raahe*

towards VR, and it is also an innovative approach to proactive safety work. “The walking beam furnace is emptied and cooled once a year for maintenance. For some of the maintenance staff, annual maintenance is the first time that they access the site and the timeframe for orientation is often limited. VR allows our maintenance people to try out beforehand – as if they would step inside – and learn about the safety issues ahead of time. This will have significant impact on workplace safety,” explains Pekka Paganus, Maintenance director at SSAB Raahe.

The furnace model was completed in 2018 and has already been used during annual maintenance safety training at the hot strip mill. In the first training session, participants learned about the furnace through a video of the virtual model. Looking ahead, participants will also be able to use virtual glasses to visit the furnace. “It will be really interesting to see how the technology and new form of training are received. Virtual modelling has enormous potential, which I believe we can use in other challenging projects and more generally when introducing the site,” Paganus adds.

SSAB Raahe is studying new objects to model so that the VR technology can be made available in providing orientation also in other challenging maintenance projects. The personnel who tried out the virtual glasses during a demo event at SSAB Raahe will also be interviewed for their suggestions for new virtual models to come.



In the VR training session, participants learn about the furnace and its maintenance area (Picture: SSAB)

SSAB



Tata Steel is developing housing systems which could provide quality, adaptable modular designs (Picture: Jakub Rozanski)

## Modern methods of construction

# Tata Steel announces vision to master housing crisis in the UK

Tata Steel announced its revolutionary vision of the UK housing market, paving the way for a new breed of homes to populate the 'Neighbourhoods of the Future' concept.

In a white paper published by Tata Steel UK in partnership with the Agile Ageing Alliance, the steel company recommends a fundamental shift in the way housing development is considered in the UK [1]. Rather than a series of rungs the consumer must climb, from starter home upwards and then back down again in later life, buildings would be capable of adaptation – of morphing to support a growing family, and then adjusting to accommodate an ageing one. This vision of a home for life can only be achieved by looking at the needs of the occupant and how they change over time.

The report comes as the UK finds itself in a housing crisis. According to the findings of a recent year-long cross-party housing

commission launched following the Grenfell Tower disaster, England needs 3.1 million new social homes by 2040, more than were built in the two decades after the end of the Second World War [2].

Henrik Adam, chief commercial officer of Tata Steel Europe, said: "In construction, housing is seen as a very challenging area. We believe there is an urgent need for a new approach to home owning throughout our lives. The basis of this starts in designing a home where a person can live, work and play throughout their lives." Well-designed spaces coupled with tailored systems are the starting point of a cradle-to-grave approach to housing design. As the needs of the occupant change over time, the space

can adapt with minimal disruption, thus reducing the need for a person to move and in turn strengthening the building and continuity of the 'neighbourhood'.

"At Tata Steel, we regard this not only as a business opportunity, but believe it is our duty to work on sustainable solutions and play a beneficial role within the society we operate in. The provision of de-



QR code storing the link (<https://t1p.de/2k6e>) to download the white paper PDF [1] from Tata's website; 340 p., 18 MB

**“We believe there is an urgent need for a new approach to home owning throughout our lives. The basis of this starts in designing a home where a person can live, work and play throughout their lives.”**

*Henrik Adam, chief commercial officer, Tata Steel Europe*

cent, affordable homes is an expression of that belief.” And he added: “We expect this white paper to serve as a valuable resource for all housing providers together with government – national, regional and local. Working collaboratively through the Agile Ageing Alliance our ambition, as a cross-sector collective, will be to build a prototype Neighbourhood of the Future, the first of many, to prove the concept.”

Neighbourhoods of the Future sets out to qualify what better actually looks like. Authored by preeminent cross-sector experts and thought leaders, the report envisages the development of “smart” intergenerational age-friendly neighbourhoods. These neighbourhoods would comprise ‘cognitive homes’ which are affordable, sustainable, easier and more efficient to construct and be connected directly with the high-tech systems tailored to meet the diverse needs of an ageing population. With the acceleration of new digital technologies designed to make lives easier and more connected, the report proposes a rethink about how the UK’s housing stock is financed, built and updated.

One of the report’s contributors, Matt Cooper, a specialist in Modern Methods of Construction (MMC) at Arup Group, said: “The creative pioneers of the new generation of MMC not only have the opportunity to alleviate our housing shortage, but to change the way housing is delivered. A

house is just a house, but homes are part of communities. Throughout our lives, the way we use our home changes. With adaptable and agile regeneration capabilities built in by design, MMC could be the game changer. Within the next 10 – 20 years, it may not only halt the downward spiral in our housing market, but act as the catalyst for a new social economy.” With clever modular designs, a house can be installed in days and can be replaced, adapted or reconfigured equally efficiently. Tata Steel is developing housing systems which could provide quality, adaptable modular designs, allowing householders to upgrade and customize homes.

Lord Best, chair of the All-Party Parliamentary Group on Housing and Care for Older People, said: “With a large, ready-made market that the unimaginative house building industry is failing to address, there are massive opportunities for creating homes for everyone. Government, local and central, stands to gain from incentivizing and supporting a major growth in this fledgling sector, not least in collaboration with housing associations. But the tipping point – when ‘rightsizing’ becomes the norm for those in their 60s and 70s – will arrive when a new generation of entrepreneurs take up the challenge. A market that is worth over £ 6 billion a year beckons. And with it comes the great prize that both older and younger

## Agile Ageing Alliance

AAA is a campaigning social business which aims to accelerate development of innovations that improve health and wellbeing in later life through smart venturing and clever collaborations. Established in 2014 to support Innovate UK’s Long Term Care Revolution in 2016 led an outreach programme for the European Commission, to inform development of a ‘European Reference Framework for Age-Friendly Housing’. This culminated in the first Neighbourhoods of the Future white paper: Better Homes for Older Adults – Improving Health, Care, Design and Technology

www.agileageing.org

generations can live in homes that make their lives better.”

Tata Steel UK

## References

- [1] Neighbourhoods of the future. Better homes for an aging population. CSL/RockCouture Productions, Ltd., 2019
- [2] Building for our future. A vision for social housing. Final report of Shelter’s commission on the future of social housing. Shelter, 2019

## Primetals Technologies launches new eService portal

**Primetals Technologies has been offering various eServices for the metals industry via a new web platform.**

With its m.space web portal, Primetals Technologies provides a wide range of innovative online services on a single web portal. The new platform includes a spare

parts store, offers eTraining and eCoaching solutions, online documentation for plants with augmented reality support as well as online support for updates and revision of documentation. It is also home for further data based services. The portal includes components and services such as m.academy, an online training platform

with eLearnings; m.doc, a document management system with redlining services; m.buy, an online spare parts catalogue; and m.crane, an online parametric engineering of crane hoisting drums.

Primetals Technologies

## Metallurgical hardware illustrated in miniature

# A Lego model blast furnace

A blast furnace at the former Thyssen steel mill at the Landscape Park Duisburg-Nord and blast furnace 1 of Altos Hornos de Vizcaya, Spain, were the inspiration for this product concept.

Lego bricks. Who is not familiar with them! These modelling bricks were launched in the form we know them today by Danish toy-maker Lego A/S in 1949, so 2019 marks a Lego bricks anniversary. In the intervening seventy years, a large and diverse range of product and topic series have developed to join the original standard Lego bricks, in many cases exhibiting an extremely high technical standard and a seemingly endless number of different models.

But scarcely anyone who has played with Lego bricks in their childhood or who, in adult life, values them as a creative leisure-time pursuit, gives any thought to the actual origins of all the ideas for new models.

One virtually inexhaustible source of new product concepts is the "LEGO® Ideas" Internet platform, on which Lego fans can discuss new products and submit their own ideas for a new model which – with a little luck – could then, via a competition, be developed up to production status.

### Authentic replicas of industrial facilities

One such "product developer" is Yvonne Strijbos, who has, among other things, a weakness for true-to-life reproductions of industrial locations. Her creativity has already furnished Lego product ideas for a dolomite plant, a mine and two chemical plants.

The current question is whether her latest product idea – a blast-furnace installation – will find enough supporters to bring it at some future time to Lego enthusiasts in the form of a kit or a set of instructions.

The prototype for her model was provided by the blast furnace at the Landscape Park Nord open-air industrial museum on the site of the former Thyssen steel mill in Duisburg, Germany, and by blast furnace



**Lego replica of a blast-furnace installation** (Picture: Yvonne Strijbos)

1 at Altos Hornos de Vizcaya, in Spain. The model includes, inter alia, all the essential components of a blast-furnace installation, such as the furnace itself, the cast house, the hot blast stoves, the bunkers for the burden, the downcomers and – perhaps slightly overdimensioned when set against the blast furnace – a torpedo ladle, all faithfully modelled down to the last detail. To enter the competition, Yvonne Strijbos had to redesign her original model, with its approx. 13,000 bricks, into a simplified variant of only 3,000 bricks, however (any individual project must consist of a maximum of 3,000 bricks to be eligible for the competition).

The Lego "Blast Furnace" project has already attracted one hundred supporters in its first sixty days. This is an important milestone, since Yvonne Strijbos needed to achieve this figure to obtain an extension for her project. The aim now is to gain 1,000 more supporters for this concept within another year, in order that it may actually have a chance of becoming



This QR code provides a direct link to the blast-furnace model at Lego Ideas: <https://t1p.de/1bcl>

reality. In the background, the company monitors how the model is received by the fan community.

The final sprint comes once a concept has attracted 1,000 supporters. The project needs a further 5,000 votes in the subsequent six months, and then another 10,000 "likes" within a further six-month period. The competition then concludes. Ultimately, a review board decides whether, perhaps, a real Lego product will follow up the original concept. The QR code will take readers straight to the "Blast Furnace" product idea. Or simply use the following link: <https://t1p.de/1bcl>

Yvonne Strijbos

## History of the metallurgical works in Europe

# The iron and steel industry in the Ukraine during World War I

At the beginning of the 20th century Ukraine was the main producer of steel, coal and iron ore of the Russian Empire. Ukrainian iron and steel sites were located far away from the battle fields of World War I. Nonetheless, wartime industrial operations were greatly affected by serious problems, including disorganized transport, mobilization and lack in food supply, as well as increasingly adverse repercussions of the revolutions and political instability. Finally, what used to be flourishing sector came out of the war as a deeply depressed sector.

## Political context

This analysis of the Ukrainian iron and steel industry during the World War I is taking into consideration the numerous changes in the political status of the territories making up modern Ukraine. The timeline of this period is very briefly summarized as follows:

- Before World War I most of the territory was part of the Russian Empire – except Galicia, the large south-western region belonging to Austria-Hungary.
- In the aftermath of the Russian Revolution in March 1917, the Ukrainian People's Republic (UPR) was declared on 10 June 1917. Initially, the UPR was part of the young Russian Republic.
- After the Bolshevik Revolution (7 Nov. 1917), Red Guards occupied the north-eastern regions of Ukraine and constituted the Ukrainian People's Republic of Soviets (UPRS or Soviet Ukraine) on 22 Dec. 1917, with Kharkiv being the capital. Hence, UPRS belonged to the Russian Soviet Federation of Socialist Republics (Soviet Russia).
- UPR proclaimed independence on 25 January 1918.
- On 9 February 1918, Central Powers concluded in Brest a protectorate treaty (known as "peace for bread": Germany and Austria-Hungary secured food supply in return for military protection) with UPR and recognized it as a neutral state.
- After signature of the Treaty of Brest-Litovsk (3 March 1918; Russia – Central Powers), Soviet Russia agreed to recognize the state UPR and, after signing the peace treaty, withdrew its troops.
- The self-declared Donets-Kryvyi Rih Soviet Republic (12 Feb. 1918) and other short-lived formations alike were abolished due to Treaty of Brest-Litovsk.
- After a coup d'état (29 April 1918), the country's name was changed to Ukrainian State (also known as Hetmanate), governed by General Pavlo Skoropadsky as a monarch; relative peace lasted until November 1918.
- 13 November 1918 – two days after the end of World War I – Soviet Russia annulled the Treaty of Brest-Litovsk and refused to recognize independence of Ukraine.

The above timeline is a very brief summary of untold political developments in Ukraine and the neighbouring countries during the wartime 1914 – 1918 and the following years.

## Establishing the early iron and steel industry in the late 19th century

The modern history of Ukraine's metallurgy industry starts in the second half of 19th century. In 1869, the Novorossiysk Coal, Iron & Rail Production Company was established by a British-Russian consortium initiated by John Hughes, a Welsh entrepreneur. The first 240 m<sup>3</sup> blast furnace was built and blown in in 1871 next to a coal mine on the territory of modern Donetsk. (The initial name of the town "Yuzovka" originates from the transliteration of Hughes' name.) That blast furnace processed the local low-grade iron ore. The technology and equipment used



Locations of steelworks on a political map of Ukraine in 1917 – 1918



Output of pig iron, steel and rolled products during 1913 – 1917 [1]

Year	Pig iron		Steel		Rolled products	
	million t	% to 1913	million t	% to 1913	million t	% to 1913
1913	2.82	100.0	2.38	100.0	2.01	100.0
1914	2.78	98.4	2.47	103.6	2.21	102.3
1915	2.51	89.1	2.21	92.3	1.81	89.0
1916	2.66	94.1	2.38	99.8	1.90	91.3
1917	1.93	68.5	1.58	66.6	1.16	57.1

was well behind the state-of-the-art at that time.

In 1875, commercial mining of high-grade iron ore began at the Kryvyi Rih deposit (discovered in 1866). A new railway launched in 1884 connected Kryvyi Rih industrial city with the Donets Basin, boosting iron and steel production in the south-eastern part of Ukraine. Shortly afterwards two industrial regions – the largest ones in Eastern Europe – evolved: one in the Donets Basin (coal mining, steelmaking and machinery manufacturing) and the other – in the vicinity of Katerynoslav (now Dnipro), including Kamyanske, Oleksandrivsk, Krukivka, Kryvyi Rih, and Nikopol (mining of iron and manganese ores, steelmaking, and machinery manufacturing).

The city of Katerynoslav became a very profitable location thanks to a railway bridge crossing the Dnipro river (approx. 1 km width) and linking with the coal and ore supply via the river. Here at the Oleksandrivsk steelwork operated by the Briansk Joint Company (now – Dniprovskiy Metallurgical Plant) the first blast furnace designed to the state-of-the-art of that time was blown in in 1887. By the end of 1888 it became an integrated steelwork with two blast furnaces, steel shops (Bessemer converter and open-hearth furnaces) and with rolling mills producing sheet, rails and other long products.

In 1889, just 40 km up the river, near the village of Kamyanske another large integrated steelworks was commissioned (now Dniprovskiy Iron & Steel Integrated Steelworks).

Several iron and steel facilities in Druzhkivka, Almazna, Petrovske in the Donets Basin along with two facilities in Mariupol

near the Azov Sea and the Gdantsevka iron-making plant in Kryvyi Rih were erected during 1892 – 1898. These enterprises were designed and built with the help of foreign investment, involving Belgian, French, German and U.S. technology. In 1899, more integrated steelworks were built – in Makiivka, Kramatorsk of the Donets Basin and in Kerch at Crimea.

Direct foreign investment and technology transfer were essential for the rapid industrial development. Besides the integrated steelworks, several rolling mills were commissioned in the 1890s: in Katerynoslav a French-Belgian company “Cheaudoir Brothers” built two pipe-rolling mills and one sheet-rolling mill; in Mariupol a pipe-rolling mill relocated from the U.S. was launched.

### Depression at the turn of the century

During the economic crisis started in 1900, most of new enterprises survived, whereas old shops with charcoal-fuelled blast furnaces in Polissya (Western Ukraine) were closed. During the period from the crisis in 1900 until the beginning of World War I, no new steelmaking facilities were built, although the production volume was growing rapidly – starting from 1910. By 1913, compared to 1900, production had grown as follows: hot metal + 210%, crude steel + 235%, rolled products + 250%.

Electrification of the facilities was beginning: in 1913 steelmaking facilities had a total of 3,211 electric drives with a cumulative power of 87 MW and 306 electrically driven cranes. At the blast furnace plants, the blowers and hoists were being equipped with 6.2 MW electric drives, and

the rolling mills with 27 MW ones. In 1913, power stations of steel facilities generated over 120 GWh of electricity. Nevertheless, although Ukrainian factories were designed based on foreign equipment, the level of electrification was generally behind that found in West European and U.S. facilities.

As explained above, many enterprises were launched within a very short period. This boom was triggered to a great extent by the possibility of gaining substantial subsidies and preferences from the government. Sometimes, owners paid large dividends during the first initial years of operation without taking care of building up current capital. Some enterprises did not take into consideration the local conditions, the availability of raw materials, logistics, skilled human resources etc. Many facilities had been erected in such a hurry that sometimes need of reconstruction was obvious as early as just after commissioning. These aspects played role in understanding the resilience of enterprises to wartime challenges [2].

### The industry at the onset of World War I

Ore mining in the Kryvyi Rih Basin boosted from 0.1 million t in 1881 to 6.4 million t in 1913, supplying 95–97% of the iron ore used in the Ukrainian steel industry. Simultaneously manganese ore mining in Nikopol began in 1886, reaching 276,000 t in 1913 [3]. Starting in 1914, sintering and briquetting of iron ore fines and top dust was mastered: a sintering plant with six pots for top dust sintering was built in Katerynoslav.

**Ironmaking.** In 1914, the average volume of a Ukrainian blast furnace was 389 m<sup>3</sup> (max-

*Prof. Dr. Volodymyr Shatokha, vice-rector; Prof. Dr. Arkadiy Tarakanov, chair of Ironmaking; National Metallurgical Academy of Ukraine, Dnipro, Ukraine*



Iron ore mining in Kryvyi Rih (1899)



Gdantsevka ironmaking plant (1899)

imum: 650 m<sup>3</sup>) and the average production was 67,200 t of hot metal per year. Productivity generally was behind the advanced contemporary level. Specific coke consumption was as high as 1.12 – 1.22 t per ton of hot metal. The average number of personnel per blast furnace was 215, most of whom were wheelbarrow workers. The breakdown of pig iron produced was as following:

- steelmaking iron 77%,
- foundry iron 22%,
- ferromanganese 0.8%,
- ferrosilicon 0.2%.

Most of the blast furnaces had four hot blast stoves that provided hot blast at temperatures of 300 – 450°C. Production intensity was limited by the blowers' power. The maximum power of the steam-powered blowers was 3,625 hp.

The blast furnace design had typically had the following drawbacks: small hearth diameter, tall and low-pitched boshes and so on. Most blast furnaces had a hearth diameter of 3 – 4 m and were 22 – 27 m tall.

**Steelmaking.** In 1914 steel production took place in 72 open-hearth furnaces, 17 Bessemer converters and seven Thomas converters. Two electric arc furnaces were in operation at the steel facilities in Konstantynivka and Makiivka.

At the Bessemer converter the air was blown in via a bottom box at the pressure of 2.0 – 2.5 bar. The blowing period for the 25-t converter lasted for about 25 min. The downtime due to failure of the equipment reached 40%. The quality of the nitrogen saturated steel was rather mediocre.

The open-hearth furnace technology allowed production of a wide range of quality grade steel. Mostly a scrap-and-ore method was applied with a mixed charge of scrap, iron

ore, limestone and pig iron with increased manganese content. Steel was cast into small ingots using a siphon method. The open moulds had no warming extensions, which resulted in low ingot quality.

Steelworks with open-hearth furnaces accounted for 74% of the total steel output in 1914. Newer open-hearth furnaces were operated with charges of 50 – 60 t. Average productivity of the open-hearth furnace was 24,500 t/year and the average bath surface area was 28 m<sup>2</sup>. Heating capacity of the open-hearth furnace was limited due to the use of low-calorific gas provided by the coke plants. Durability was insufficient owing to the absence of water cooling.

**Rolling mills** had been substantially modernized by 1914 thanks to the deployment of electric drives and the improvement of the equipment. At the beginning of 1914, the mills had an annual production capacity of 7.424 million t. The breakdown of mill types was as follows:

- 9 primary mills (3673.6 kt/a),
- 6 rail and beam mills (1504.0 kt/a),
- 8 heavy section mills (691.2 kt/a),
- 8 medium section mills (373.6 kt/a),
- 11 light section mills (244.8 kt/a),
- 6 wire rod mills (302.4 kt/a),
- 10 plate mills (371.2 kt/a),
- 5 billet mills (116.8 kt/a),
- 15 hot strip mills (214.4 kt/a),
- 1 tire mill (32.0 kt/a).

Although machinery manufacturers in Kramatorsk and Horlivka were gradually becoming capable of producing the relevant equipment, most of the rolling mills were still being built with imported equipment.

The level of mechanization was low resulting in hard manual work. The canting of the blooms at the blooming and section mills

was done manually by the workers. The best equipped heavy and medium plate mills were in operation in facilities located in Katerynoslav, Kamyanske and Mariupol. All hot strip mills had single stands in 2-high or 3-high configuration, using the pack rolling method.

As the war began, existing facilities were unable to satisfy the growing demand for steel. Before the naval blockade was imposed on Russia in 1915, over 15% of finished steel products was imported (indirect imports not included). Structural rolled products for the precision machinery industry were not produced in sufficient quantities to satisfy the great demand. Therefore imports of such products were substantial.

**Cokemaking** developed rapidly in Ukraine before World War I, so that after occupation of Poland, the Donets Basin produced nearly 90% of the total coke output of the Russian Empire. As many as 5,182 coke ovens were in operation at that time, 1,784 of which at steelworks, and the remaining vast majority close to the coal mines. However, only 30% of the capacity was equipped with technology for by-product recovery. Only one company produced benzol which became increasingly valuable for the manufacture of explosives. (The other coke plants equipped with by-product recovery system produced only tar and ammonia water.) In 1913, 4.45 million t of coke were produced, and in 1914 production coke output remained at the same level. However, in 1915, owing to transportation problems, lack of coal and mobilization of workers, coke production decreased by 9.7% and in 1917 by 17% compared to the 1913 level [4].

Supported by the government, the Kokso-benzol Joint Company was established in order to increase the recovery of benzol to a level adequate for the manufacture of

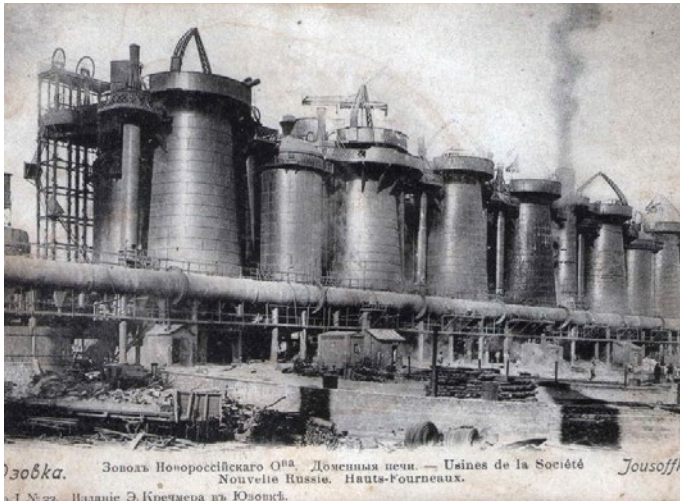

**Ironmaking shop of Novorossiysk Coal, Iron & Rail Production Company in Yuzovka**



**Panoramic view of steelworks in Yuzovka (1914)**

explosives. Hence, the production of benzol increased from 32 kg in 1913 to 2,096 kg in 1916. Apart from that, within the framework of a contract between a Belgian company and the Main Artillery Department a new coke-making plant was built and started up in the second half of 1916 [5]. This new plant was able to produce not only raw benzol (annual capacity of 4.8 t) but also xylene and toluene.

### **Decline of steel production during World War I**

As a result of imports from Polish steelworks no longer being available since 1915, the share of Ukrainian steel in the total output of the Russian Empire reached 75%. Despite the growing demand for steel, the output from Ukrainian steelworks decreased most sharply in 1917, owing to the below described problems.

Initially, the drop in production was caused by insufficient supply of iron ore, fuel and refractories – mostly due to transportation issues. Railway transport had to cope with military transportation, which had priority, and the evacuation of equipment and refugees. Therefore there was not enough capacity for serving the steel industry as required. Authorities commandeered part of privately owned locomotives and rededicated them for military transport. Gradually, lack of fuel became an issue. However, the problems with transportation were not that critical until the winter of 1916/17. But then problems with the railways became crucial due to general disorganization caused by the revolutions. Some railway tracks, bridges as well as equipment of stations were destroyed during the Bolshevik offensive into Ukraine in February 1918. Later, in spring 1918, when German troops were deployed

on Ukrainian territory (being a protecting power according to the Brest Treaty) the railways were generally restored and by July 1918 transportation was restored.

There was a severe lack of qualified personnel during the war, mostly due to mobilization, which also contributed to decreased output of iron ore and coal. In order to fill up the lacking labour force, the companies hired women and under-aged: in January 1915 the share of women employed on steelworks was 19.2%, while by January 1916 it had raised to 25%. Prisoners of war also were increasingly placed for working in the industry. In the summer of 1915, the government decided to admit under-aged and prisoners of war to work in coal mines, including underground and during night shifts. In August 1915, of the 155,000 workers in Ukrainian coal mines 20,000 were prisoners of war. One year later, in September 1916, the number of people employed in coal mines reached 237,000, including 44.1% men with suspension from mobilization, 20.2% prisoners of war, 5.2% women, 7.2% under-aged, 1.0% refugees and 22.3% other people (e.g. men unqualified for military service). Totally, 155,000 prisoners of war were relocated from agricultural jobs to the mining and industrial sectors. At the beginning of 1917, prisoners of war accounted for 30% of the workforce in iron and steelworks [5].

Following the pre-war practice, the metals production and supply in the Russian Empire was governed by the industrial syndicate «Prodamet». Therefore producers sometimes on purpose operated below their full production capacities in order to keep the prices on the highest possible level in the interest of the monopoly.

Due to the effects of the numerous factors described above, capacity utilization

of the blast furnaces was only 75.8% in 1915. At the largest steelmaking location in Katerynoslav, two blast furnaces were completely idled, while the others were operated at 60% of their capacity.

### **Transformation of the industry during World War I**

To benefit from the most profitable government orders many steelworks launched mechanical shops, primarily to produce artillery shells; many cases were reported in which shops initially designed to produce sophisticated machinery for the mining and steel industry also switched to the rather simple production to shells, often ignoring the production of less profitable but indispensable for industry machinery [4]. Sometimes steelmaking companies decreased production of less profitable but vital items: e.g. Donets-Yurievsk factory reduced production of rails from 2,020 t in 1913 to 1,500 t in 1915 and to 750 t in 1916 disregarding the needs of the railway, while increasing the output of sections.

Gradually, to better secure the supply of raw materials, some companies, initially specialized in the iron and steel sector, were transformed into vertically integrated enterprises: e.g. during 1914 – 1915 Donets-Yurievsk Metallurgical Company purchased several coal and ore mines. Industrial companies also merged with the enterprises from the financial and banking sectors. In 1916, Russian-Asian Bank participated in the merger of Novorossiysk Coal, Iron and Rail Production Company (former Hughes steelwork) with South-Russian Company specialized in ammunition manufacturing, resulting in the creation of a giant combined enterprise

with a share capital of 60 million roubles. In 1916, the merger of Maltsev Plants Company (operating enterprises in various sectors across the whole Russian Empire) with the Mining Metallurgical Union (owning steelmaking and pipe-rolling mills as well as coal and ore mines in Ukraine) was another significant step. With this merger a huge steel and military trust was established.

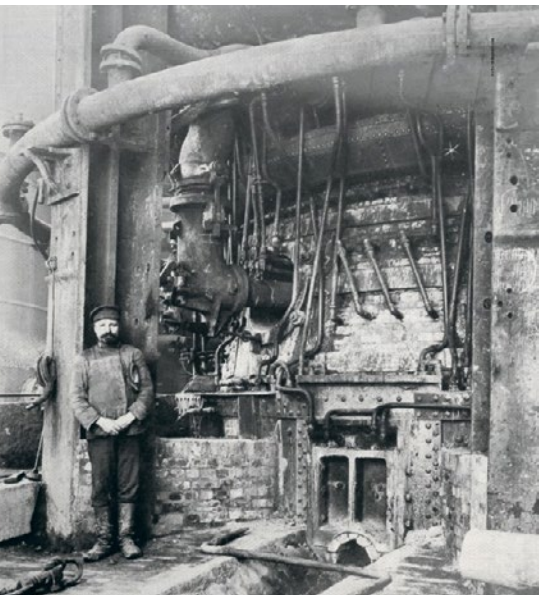

Blast furnace in Yuzovka

### Socioeconomic tensions and disorganization of the economy

During the war, a gradual transition of the relations between the owners of enterprises and employees was taking place. During 1914 – 1915 the entrepreneurial spirit generally persisted. However, many revolutionary parties took advantage of the worsening economy and played on the fears of the workers who finally became radicalized. From 1916 onwards the operation of many steel mills was affected by strikes. These strikes were usually triggered by socialist propaganda and often demanded nationalization of factories under the pretext that the government would increase the salaries for working class people, while private owners were only interested in maximizing their own profit.

After the Russian Revolution in April 1917, the Transitional Government approved the establishment of Workers' Committees at enterprises. These committees initially focused mostly on economic demands such as the 8-hours workday, which, being introduced without preparation, had severe re-

percussions on operations: e.g. in autumn 1917 workers willingly stopped some of the blast furnaces in Katerynoslav for the sake of forcing through the 8-hours workday.

The Transitional Government tried to support the steel companies financially providing them with loans amounting to 18.6 million roubles. Nevertheless, due to the general disorganization of the economy, the situation in the steel sector was rapidly worsening. During the second half of 1917, mostly owing to the lack of raw materials and fuel, the mills in Druzhkivka, Kostiantynivka, Almazna, Kerch as well as the Russian Providence of Mariupol stopped production. At the other locations a significant number of blast furnaces, steel shops and rolling mills also stopped production.

Shortly after the Bolshevik Revolution (7 Nov. 1917), the Council of People's Commissars (soviet government) issued a decree "On Workers' Control" legalizing the right of the Workers' Committees to control all aspects of factory operation including production, purchases, sales, financial issues and so on. In the Ukrainian territory controlled by Soviet Russia this was used as an instrument to remove the owners from the management, i.e. a direct instrument for establishing "dictatorship of the proletariat". This, however, usually resulted in complete disorganisation of operations. In his memoirs Denikin (a leading general of the White Movement in the forthcoming Civil War) noted that workers seized control over the enterprises without any understanding of management; by spending the current capital they guided the enterprises to ruin and themselves to unemployment and misery [6, p.158].

After retreat of the Red Army from the most of Ukraine's territory in spring 1918, the situation changed. Workers' Committees had been dismissed and salaries reduced. In June 1918, Hetmanate issued a decree on the renewal of the order of Russian Empire of 1905 on punishment for participating in strikes at the enterprises of state-level significance. Even lashing of workers for taking part in the political meetings was practiced. However, in many cases, workers in revenge spoiled the equipment (e.g. by stopping the pumps to flood the mines) and left the factories for good: most of them had come from rural areas with strong ties to their villages [4].

However, after revolutions and occupation by Soviet Russia the situation in the whole economy went out of hands to such an extent that the Hetmanate was unable to bring the industry back to order. So disorganization of

the economy continued. While steelworks employed 99,810 workers in December 1916, workforce dropped to only 25,600 in August 1918. Lack of food supplies also contributed to this situation. In September 1918, the Novorossiysk Coal, Iron & Rail Production Company appealed to the Hetmanate, noting that even during the hardship of 1916 the company had managed to produce 240,000 t of hot metal, 224,000 t of crude steel, 240,000 t of rails and other finished products. But since August 1918 it had had to shut down completely because, due to the lacking food supply, many qualified workers had been abandoning the factories. The appeal asked for the supply of food for 25,000 workers at the mills and mines, for 75,000 family members as well as forage for 3,000 horses [4].

During seven months from January to July 1918, only 264,000 t of iron ore were supplied from the Kryvyi Rih mines, whereas before the war average monthly supply was around 480,000 t. In August 1918, all iron ore mines in Kryvyi Rih were idled and most of them flooded. There were only 2,500 workers at the mines instead of 25,000 before the war.

Lenin once said "Donbas is not just a common region, but a region without which the construction of socialism would simply remain a wishful thinking" [7, p.107]. Therefore, during the Civil War evolved in the aftermath of World War I, the industrial Pre-Dnipro region as well as Donetsk Basin were among the most fiercely contested territories: in Katerynoslav, during 1917 – 1921 the ruling powers changed 18 times (some of the "republics" survived just for two weeks). In this turmoil the Ukrainian industry was devastated completely: in 1920 production of steel was 1.7%, of rolled product 1.8% and of coal 22% of the 1913 level [8].

### References

- [1] Development of metallurgy in Ukrainian SSR, Ed. by Z.I. Nekrasov. Kyiv, Naukova dumka, 1980. (in Russian)
- [2] Shliakhov O.B. Peculiarities of the development of heavy industry in Ukraine during the end of XIX – beginning of XX century: back side of «great leap». Humanitarian Journal, 2012 (1) 94–100 (in Ukrainian)
- [3] Internet Encyclopaedia of Ukraine: Southern Ukraine. Available at <http://t1p.de/y6am> (in Ukrainian)
- [4] Syniavska L. I. Heavy industry of East and South of Ukraine during the First World War: Doctoral Thesis, Kyiv, 2015. (in Ukrainian)
- [5] Syniavska L. I. The development of the metallurgy industry in Eastern and Southern Ukraine in 1914–1916. The Bulletin of Cherkassy University, 2014 (9) 98-104 (in Ukrainian)
- [6] Denikin A.I. Sketches of Russian revolt, Minsk, 2002 (in Russian)
- [7] Lenin V.I. Complete works, Vol. 45. Moscow, Progress, 1960–72 (in Russian)
- [8] Alexeyev S.V, Dovbnia O.A., Liashenko Y.P. History of Ukraine: brief course. Kramatorsk, 2007. (in Ukrainian)

## Conferences and symposia

<b>ITA Conference</b>	10 – 11 April 2019 Düsseldorf, Germany	International Tube Association (ITA) <a href="http://www.conference.itatube.org">www.conference.itatube.org</a>
<b>TOOLING 2019</b>	12 – 16 May 2019 Aachen, Germany	TEMA Technologie Marketing AG <a href="http://www.tema.de">www.tema.de</a>
<b>CHS<sup>2</sup> – Conference on Hot Sheet Metal Forming of High-Performance Steel</b>	2 – 5 June 2019 Luleå, Sweden	Luleå University of Technology, Division of Mechanics of Solid Materials, <a href="http://www.chs2.eu">www.chs2.eu</a>
<b>ESTAD – European Steel Technology and Application Days</b>	24 – 28 June 2019 Düsseldorf, Germany	Stahlinstitut VDEh <a href="http://www.metec-estad2019.com">www.metec-estad2019.com</a>
<b>ESSC – European Stainless Steel Conference &amp; Duplex Stainless Steel Conference</b>	30 Sep. – 2 Oct. 2019 Vienna, Austria	The Austrian Society for Metallurgy and Materials (ASMET), <a href="https://www.stainlesssteel2019.org">https://www.stainlesssteel2019.org</a>

## Exhibitions, trade fairs

<b>Tube &amp; Steel Istanbul Fair</b>	17 – 20 April 2019 Istanbul, Turkey	Tüyap Fairs and Exhibitions <a href="http://www.tubeandsteelistanbulfair.com">www.tubeandsteelistanbulfair.com</a>
<b>AIStech 2019</b>	6 – 9 May 2019 Pittsburgh, PA (USA)	Association for Iron & Steel Technology <a href="http://www.aistech.org">www.aistech.org</a>
<b>Made in Steel</b>	14 – 16 May 2019 Milan, Italy	Made in Steel S.r.l. <a href="http://www.madeinsteel.it">www.madeinsteel.it</a>
<b>Metallurgy, Litmash, Tube Russia</b>	14 – 17 May 2019 Moscow, Russia	Messe Düsseldorf <a href="http://www.tube-russia.com">www.tube-russia.com</a>
<b>Stainless 2019</b>	15 – 16 May 2019 Brno, Czech Republic	Verlag Focus Rostfrei <a href="http://www.stainless2019.com">www.stainless2019.com</a>
<b>China Metal &amp; Metallurgy Exhibition</b>	13 – 15 June 2019 Guangzhou, China	Guangzhou Julang Exhibition Design Co. <a href="http://www.julang.com.cn/english">www.julang.com.cn/english</a>
<b>SEAIISI 2019</b>	17 – 20 June 2019 Bangkok, Thailand	South East Asia Iron & Steel Institute <a href="http://www.seaisi.org">www.seaisi.org</a>
<b>GIFA, METEC, THERMPROCESS, NEWCAST</b>	25 – 29 June 2019 Düsseldorf, Germany	Messe Düsseldorf <a href="http://www.metec.de">www.metec.de</a>

## Seminars

<b>Electrical Engineering of Arc Furnaces</b>	8 – 10 April 2019 Duisburg, Germany	Steel Academy of the Steel Institute VDEh <a href="http://www.steel-academy.com">www.steel-academy.com</a>
<b>Continuous Casting</b>	26 – 29 August 2019 Cologne, Germany	Steel Academy of the Steel Institute VDEh <a href="http://www.steel-academy.com">www.steel-academy.com</a>
<b>Refractory Technology I</b>	24 – 27 November 2019 Cologne, Germany	Steel Academy of the Steel Institute VDEh <a href="http://www.steel-academy.com">www.steel-academy.com</a>

## Preview of the June 2019 issue:

### Technology

#### Online monitoring of the slab temperature during hot transfer

A specific online temperature model has been used to monitor the slab temperatures during hot transfer from the casting plant to downstream operations. This has improved process security of the hot transfer and makes for uninterrupted, model-based monitoring of the slab condition – an important step towards a digitalized steel mill.

#### The next step towards fossil-free steelmaking

A sustainable decrease of greenhouse gas emissions in steelmaking can be achieved by implementing a new hydrogen process in the DRI-EAF-route. The newly developed solution consists in a direct reduction process development replacing methane with hydrogen thus no longer releasing CO<sub>2</sub>. A feasibility study has been recently ordered by a European manufacturer for the reduction of greenhouse gas (GHG) emissions in relation to the decommissioning of BF/BOF-based plants in favour of the use of DRI and EAF.

### Steel processing

#### The smart future of metalworking

Digitalization and networking are rapidly gaining ground in metalworking – and the same trend is also taking place in storage and sawing technologies. Manual and mutually-isolated processes are increasingly giving way to a continuously-controlled, intelligent material flow, in which all the components involved communicate autonomously with each other. Digital solutions make metalworking more efficient, more flexible and more cost-efficient in the era of Industry 4.0.

### Steel trade

#### AHS steel market investigation highpoints Europe as in the leading position

Advanced high strength steel is being actively employed in the automotive industry. Vehicular safety functions are a key growth factor across developed and developing economies, thereby creating constant opportunities for advanced high strength steel manufacturers.

#### Publishing house

DVS Media GmbH  
PO Box 10 19 65, 40010 Düsseldorf, Germany  
Aachener Straße 172, 40223 Düsseldorf, Germany  
Phone +49 211 1591-0  
Fax +49 211 1591-150  
E-mail [media@dvs-hg.de](mailto:media@dvs-hg.de)  
Internet [www.dvs-media.eu](http://www.dvs-media.eu)  
[www.homeofsteel.de](http://www.homeofsteel.de)

#### Management

Dirk Sieben

#### Editorial board

Dipl.-Ing. Arnt Hannewald (responsible)  
Phone +49 211 1591-232  
E-mail [arnt.hannewald@dvs-media.info](mailto:arnt.hannewald@dvs-media.info)  
Hara Paliokosta  
Phone +49 211 1591-148  
E-mail [hara.paliokosta@dvs-media.info](mailto:hara.paliokosta@dvs-media.info)  
Edith Mielke  
Phone +49 211 1591-205  
E-mail [edith.mielke@dvs-media.info](mailto:edith.mielke@dvs-media.info)

#### Advertising

Markus Winterhalter (responsible)  
Phone +49 211 1591-142  
E-mail [markus.winterhalter@dvs-hg.de](mailto:markus.winterhalter@dvs-hg.de)  
Katrin Kuchler  
Phone +49 211 1591-146  
E-mail [katrin.kuechler@dvs-media.info](mailto:katrin.kuechler@dvs-media.info)

For currently valid prices see Price List No. 1, effective January 1st 2019.

#### Reader Service

DVS Media GmbH  
Phone +49 211 1591-148  
Fax +49 211 1591-150  
E-mail [vertrieb@dvs-hg.de](mailto:vertrieb@dvs-hg.de)

#### Graphic design

Maximilian Schmitz  
Phone +49 211 1591-141  
E-mail [maximilian.schmitz@dvs-media.info](mailto:maximilian.schmitz@dvs-media.info)

#### Printing

Kraft Premium GmbH  
Industriestraße 5–9  
76275 Ettlingen, Germany

STEEL + TECHNOLOGY is printed on chlorine-free bleached paper.

#### Terms of Delivery

STEEL + TECHNOLOGY is published four times a year and is available on subscription. The price for a one-year subscription for print and e-paper is 115.00 € incl. shipment (VAT not included). Subscriptions will be renewed for the next 12 months, unless DVS Media GmbH receives a written cancellation 6 weeks prior expiration. VAT calculated in accordance with EC legislation.

Single copy:  
35,00 € excl. shipment

#### Copyright

STEEL + TECHNOLOGY as well as all contributions, figures and tables included in this journal are protected by copyright. With the exception of statutorily authorised cases, any utilisation without the consent of the DVS Media GmbH is punishable. We do not accept any liability for manuscripts submitted without solicitation.

ISSN (Print) 2627-9665  
ISSN (Online) 2627-9673

Danieli & C. Officine Meccaniche SpA	6,7	LOI Thermprocess GmbH	59
DVS Media GmbH	35, 43, 67, 95	Messe Düsseldorf GmbH	96
GLAMA Maschinenbau GmbH	53	Rump Strahlanlagen GmbH & Co. KG	23
GSB group GmbH	21	SMS group GmbH	2
Jasper Gesellschaft für Energiewirtschaft und Kybernetik mbH17		Walzengießerei Coswig GmbH	31
Kiro-Nathaus GmbH	27	WOKO Magnet- und Anlagenbau GmbH	13

# MEDIA KIT AT METEC YEAR 2019

Media-Information 2019



Decision makers rely on quality!



Here you can go directly to the current media kit:  
[www.homeofsteel.de](http://www.homeofsteel.de)

Contact person:  
Markus Winterhalter  
T: +49 211 1591 142  
[markus.winterhalter@dvs-hg.de](mailto:markus.winterhalter@dvs-hg.de)



# METEC



25-29 JUNE  
DÜSSELDORF  
GERMANY

# 2019

# METEC

10<sup>TH</sup> INTERNATIONAL METALLURGICAL  
TRADE FAIR WITH CONGRESSES



The Bright World of Metals

**NI**  
worldwide

## Key technology - metallurgy

METEC, with the area of forging technology, is the leading global event for the production and processing of raw iron, steel and non-ferrous metals.

## Theory meets practice

Supporting events, such as the 4th European Steel Technology and Application Days (ESTAD), are discussion forums for new steel technologies and applications at the highest level worldwide.

Welcome to  
Düsseldorf!

metec.com  
tbwom.com



eco Metals  
EFFICIENT PROCESS SOLUTIONS



METEC &  
4<sup>TH</sup> ESTAD  
2019  
JUNE 24-28

European Metallurgical Conference  
**Emc 2019**  
June 23 - 26

Messe Düsseldorf GmbH  
P.O. Box 10 10 06 \_ 40001 Düsseldorf \_ Germany  
Tel. +49 211 4560-01 \_ Fax +49 211 4560-668

www.messe-duesseldorf.de



Messe  
Düsseldorf